

Form 19115
(937)
Printed in U. S. A.

LIST OF PARTS



MACHINES
Nos. 122-1 and 122-2

THE SINGER MANUFACTURING COMPANY

INSTRUCTIONS FOR OILING

Use Singer "Manufacturing Sewing Machine Oil (Cloth and Leather)"

To ensure easy running and prevent unnecessary wear of the parts which are in movable contact, the machine requires oiling and when in continuous use it should be oiled and greased at least twice each day. Oil holes are provided for all bearings which cannot be directly reached. Grease should be applied to all gears to keep them thoroughly lubricated. The shuttle should be oiled often enough to keep it thoroughly lubricated.

Copyright, U. S. A., 1922 and 1937,
by The Singer Manufacturing Co.
All Rights Reserved for all Countries

INDEX

	Page
Accessories.....	20
Bobbin Winder.....	20
Driving Attachment (for 122-2 Machine).....	18
Machine No. 122-1.....	5
Machine No. 122-2.....	17
Numerical List of Parts.....	25
Obsolete Parts.....	21
Thread Unwinder.....	21

INSTRUCTIONS FOR ORDERING

In ordering from this list, use ONLY the part NUMBER in the FIRST column.

The number stamped on a Sewing Machine Part is in every case the number of the single part only.

Every combination of parts sent out as such has its specific number, which, although not stamped on the parts, must be used when ordering the combination.

Each number always indicates the SAME PART in whatever list it appears, or for whatever machine.

The letters after some of the numbers indicate the style of finish only, as follows:

- A-Hardened, Polished, Nickel Plated and Buffed
- B-Polished, Nickel Plated and Buffed
- C-Hardened Only
- D-Polished Only
- E-Soft, Not Polished
- F-Hardened and Polished
- F.J-Hardened, Polished and Nickel Plated
- G-Bright Rumbled and Nickel Plated
- H-Blued
- J-Nickel Plated Only
- K-Hardened and Nickel Plated
- L-Brass Plated
- M-Oxidized
- N-Japanned, Dull
- P-Japanned, Bright
- R-Merlized
- S-Cadmium Plating
- T-Copper Plated
- T.A-Hardened, Polished, Copper and Nickel Plated and Buffed
- T.B-Copper and Nickel Plated and Polished
- T.J-Copper and Nickel Plated Only
- T.K-Hardened, Copper and Nickel Plated
- T.L-Copper and Brass Plated
- T.M-Copper Plated and Oxidized
- U-Zinc Plated
- V-Silver Plated
- W-Polished and Nickel Plated
- X-Black Oxide, for Iron and Steel
- X.C-Hardened and Black Oxide, for Iron or Steel
- Y-Black Nickel Plated Only
- Z-Chromium Plated
- Z.A-Hardened, Polished, Nickel Plated, Buffed and Chromium Plated
- Z.B-Polished, Nickel Plated, Buffed and Chromium Plated
- Z.C-Hardened and Chromium Plated
- Z.J-Nickel and Chromium Plated

These letters MUST BE USED when they appear in the list; and AFTER the number as in the list.

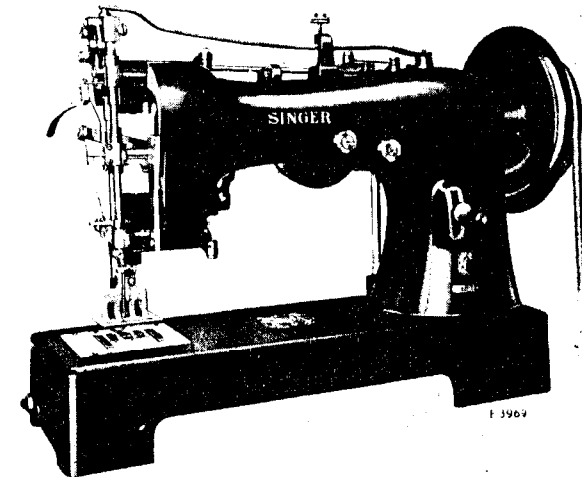
In this series:

- 1 to 1500, 50001 to 51500 and 140001 to 142000 are Screw Numbers
- 1501 to 1800 and 51501 to 51800 are Nut Numbers
- 1801 to 2000 and 51801 to 52000 are Roller Numbers
- 2001 to 50000 and 52001 to 140000 and 142001 to 190000 are Sewing Machine Parts, 190001 and upward are numbers of Electrical Parts.

The figures in the second column refer only to the plates, illustrating the parts, and are NOT TO BE USED in ordering.

Parts marked with an asterisk (*) are furnished only when repairs are made at factory.

LIST OF PARTS COMPLETE FOR



MACHINE No. 122-1

For Joining Press Cloths Made of Camel's Hair, for Straining Cotton Seed Oil. Needle and shuttle vibrate simultaneously. Throw of needle one inch each side of center; makes a zigzag line of three stitches of 5/8 inch each. Has 4 inch cylinder shuttle No. 122835, upper and under feeds and alternating pressers. Lift of presser foot 3/4 inch. Speed 300 R. P. M.

No.	Plate	Name
*122751	-----	Arm with 15404 and two 15405.....
8582	22727	" Dowel Pin.....
779E	22727	" Screw.....
122752	22751	" Shaft.....
122753	22741	" " Bushing (back).....
436C	22727	" " " " Set Screw.....
122754	22741	" " " (intermediate).....
436C	22727	" " " " Set Screw
122755	22741	" " Flanged Bushing (front).....
436C	22727	" " " " Set Screw
122756	22740	" " Gear with 445C and 888C.....
888C	22727	" " " Position Screw.....
445C	22727	" " " Set Screw.....
50262D	22727	" " Screw.....
122757	22752	Balance Wheel, 8 in. pulley, with two 795C

No.	Plate	Name
795C	22727	Balance Wheel Set Screw.....
*122758	-----	Bed.....
122759	22751	Crank Connecting Rod with two 129E.....
129E	22726	" " " Cap Screw.....
50477C	22727	" " " Hinge Screw.....
1736C	22727	" " " " " Nut.....
122761	22749	Face Plate.....
1186C	22727	" " Screw.....
122903	22751	Feed Bar with 447C.....
122763	22740	" " Hinge Pin.....
447C	22727	" " " " Set Screw.....
122895	22740	" (lower) Cam with 445C and 888C.....
888C	22727	" " " Position Screw.....
445C	22727	" " " Set Screw.....
122778	22751	" (upper) Cam with 436C and 832C.....
832C	22727	" " " Position Screw.....
436C	22727	" " " Set Screw.....
122764	22744	" Dog, 28 teeth (12 teeth to the inch) for 122905.....
704C	22757	Feed Dog Screw.....
122765	22749	" Fork.....
124079	22740	" " Collar with 445C.....
445C	22727	" " " Set Screw.....
122934	22751	" " Connection.....
8D	22727	" " " Hinge Screw.....
1583C	22727	" " " " " Nut.....
122767	22728	" " " Slide Block.....
51241C	22727	" " " " " Screw...
1513E	22728	" " " " " " Nut
122909	22740	" Lifting Cam with 445C and 888C.....
888C	22727	" " " Position Screw.....
445C	22727	" " " Set Screw.....
122768	22751	" " Rock Shaft.....
122769	-----	Feed Lifting Rock Shaft complete, Nos. 122768, 122770, 122771 and two 1396D.
122770	22741	Feed Lifting Rock Shaft Crank (front) with 692D, 1513J and 1965.....
692D	22728	Feed Lifting Rock Shaft Crank (front) Clamping Screw.....
1965	22728	Feed Lifting Rock Shaft Crank (front) Roller and Screw Stud.....
1513J	22728	Feed Lifting Rock Shaft Crank (front) Roller and Screw Stud Nut.....
122771	22749	Feed Lifting Rock Shaft Fork.....
1396D	22727	" " " " " Screw.....
1023C	22728	" " " " " Screw Center.....
1503E	22728	" " " " " Nut.
122772	22741	" (lower) Regulator.....
122773	-----	Feed (lower) Regulator complete, Nos. 1513J 9120 and 122772.....

No.	Plate	Name
50265C	22728	Feed (lower) Regulator Hinge Screw.....
9119	22728	" " " Slide Block.....
9120	-----	Feed (lower) Regulator Slide Block com- plete, Nos. 190D, 1016C, 5968 and 9119.....
190D	22728	Feed (lower) Regulator Slide Block Cap Screw.....
5968	22728	Feed (lower) Regulator Slide Block Cap Screw Washer.....
1016C	22728	Feed (lower) Regulator Slide Block Screw Stud.....
1513J	22728	Feed (lower) Regulator Slide Block Screw Stud Nut.....
254D	22728	Feed (lower) Regulator Thumb Screw.....
122774	22728	" " " " " Slide Block.....
122775	22751	Feed (lower) Rock Shaft.....
122776	-----	Feed (lower) Rock Shaft complete, Nos. 122775 and 122777.....
122777	22741	Feed (lower) Rock Shaft Crank with two 1193E.....
1193E	22728	Feed (lower) Rock Shaft Crank Clamping Screw.....
1023C	22728	Feed (lower) Rock Shaft Screw Center....
1503E	22728	" " " " " Nut.
50478C	22726	" (upper) Regulating Screw Stud.....
1513J	22728	" " " " " Nut...
122779	22726	" " " " " Sleeve
58715	22726	" " " " " Washer
122780	22739	" " Regulator with 1983.....
122781	22739	" " " Connecting Link...
866D	22726	" " " " " Hinge Screw.....
61587	22726	Feed (upper) Regulator Pin.....
1983	22726	" " " Roller and Screw Stud with 1517E.....
1517E	22726	Feed (upper) Regulator Roller and Screw Stud Nut.....
122782	22739	Feed (upper) Regulator Shaft.....
122783	22741	" " " " Collar with two 858C.....
858C	22726	Feed (upper) Regulator Shaft Collar Set Screw.....
122784	22739	Feed (upper) Rock Shaft.....
122785	22739	" " " " Crank (back) with 448C.....
61587	22726	Feed (upper) Rock Shaft Crank (back) Pin.
448C	22726	" " " " " Set Screw.....

No.	Plate	Name
858C	22726	Shuttle Cam and Gear Driver Shaft Collar Set Screw.....
122841	22739	Shuttle Cam and Gear Driver Shaft Crank with 445C.....
122842	22739	Shuttle Cam and Gear Driver Shaft Crank Connecting Link.....
50477C	22727	Shuttle Cam and Gear Driver Shaft Crank Connecting Link Hinge Screw.....
1736C	22727	Shuttle Cam and Gear Driver Shaft Crank Connecting Link Hinge Screw Nut.....
122910	22735	Shuttle Cam and Gear Driver Shaft Crank Pin.....
445C	22727	Shuttle Cam and Gear Driver Shaft Crank Set Screw.....
122843	22756	Shuttle Cam and Gear Fork.....
1916	22735	" " " " Roller.....
50481C	22734	" " " " " Screw.....
122902	22733	" " " " " Nut....
122844	22756	" Driver.....
122845	22743	" " Gear with 445C.....
8937	22733	" " " Pin.....
445C	22727	" " " Set Screw.....
122846	22753	" Driving Shaft and Gear.....
122847	22743	" " " Bushing.....
171E	22757	" " " " Screw.....
122845	22743	" " " Gear with 445C.....
8937	22733	" " " " Pin.....
445C	22727	" " " " Set Screw.....
122848	22753	" Race.....
122849	22753	" " Cap.....
51195C	22734	" " " Screw.....
16957	22733	" " " Spring.....
122850	22745	" " Connecting Link.....
50601E	22729	" " " " Hinge Screw
122851	22738	" " Guide.....
8973	22733	" " " Dowel Pin.....
1396D	22727	" " " Screw.....
122852	22753	" " Pitman.....
568D	22757	" " " Hinge Screw (left)..
1307C	22733	" " " " " (right).
1513J	22728	" " " " " Nut
122853	22753	" " Ring.....
7958	22733	" " " Position Pin.....
122854	22753	" " Shaft.....
445C	22727	" " " Set Screw.....
122913	22731	Slack Thread Controller.....
122914	22731	" " " Spring.....
11241	22731	Tension (under) Friction Washer (felt)...
19684	22731	" " " " (steel)..

No.	Plate	Name
1535E	22731	Tension (under) Regulating Thumb Nut.....
8787	22731	" " " " " " "
		Washer.....
51169C	22731	Tension (under) Screw Stud.....
575E	22729	" " " " Set Screw.....
19686	22731	" " Spring.....
122915	22731	" " Wheel.....
122916	-----	Tension (under) Wheel complete, Nos. 1535E 8787, 19684, 19686, 51169C, 122913 to 122915 and two 11241.....
8790	22731	Tension (upper) Disc.....
1660D	22732	" " Regulating Thumb Nut.....
8905	22732	" " " " " "
		Washer.....
50482E	22732	Tension (upper) Screw Stud.....
8791	22732	" " Spring.....
122855	22732	" " Thread Guide.....
122856	-----	Tension (upper) complete, Nos. 1660D, 8791 8905, 50482E and two 8790.....
122857	22745	Thread (under) Carrier.....
122858	22745	" " " Cap.....
1057E	22732	" " " " Screw.....
122859	22738	" " " Extension.....
122860	22738	" " " " Connect- ing Link.....
568D	22757	Thread (under) Carrier Extension Connect- ing Link Hinge Screw.....
57D	22732	Thread (under) Carrier Extension Hinge Screw.....
50478C	22726	Thread (under) Carrier Regulating Screw Stud.....
1513J	22728	Thread (under) Carrier Regulating Screw Stud Nut.....
122779	22726	Thread (under) Carrier Regulating Screw Stud Sleeve.....
58715	22726	Thread (under) Carrier Regulating Screw Stud Washer.....
122926	22738	Thread (under) Carrier Regulator with 51840.....
122862	22738	Thread (under) Carrier Regulator Connect- ing Link.....
568C	22757	Thread (under) Carrier Regulator Connect- ing Link Hinge Screw.....
8937	22733	Thread (under) Carrier Regulator Pin.....
5184C	22732	" " " " Roller and Screw Stud (eccentric) with 1681C
1681C	22732	Thread (under) Carrier Regulator Roller and Screw Stud Nut.....
122927	22732	Thread (under) Carrier Regulator Shaft...

No.	Plate	Name
122928	22738	Thread (under) Carrier Regulator Shaft Bushing.....
704D	22757	Thread (under) Carrier Regulator Shaft Bushing Screw.....
122864	22749	Thread (under) Carrier Rock Shaft.....
122865	22738	" " " " " Crank (lower) with 448C.....
61587	22726	Thread (under) Carrier Rock Shaft Crank (lower) Pin.....
448C	22726	Thread (under) Carrier Rock Shaft Crank (lower) Set Screw.....
122866	22738	Thread (under) Carrier Rock Shaft Crank (upper) with 858C.....
8937	22733	Thread (under) Carrier Rock Shaft Crank (upper) Pin.....
858C	22726	Thread (under) Carrier Rock Shaft Crank (upper) Set Screw.....
1396D	22727	Thread (under) Carrier Screw.....
17738	22732	" " " " Washer.....
122867	22738	" Guide (front of arm).....
122868	22738	" " Bracket.....
1057E	22732	" " " Screw.....
185D	22732	" " " Screw.....
2273	22732	" " Steady Pin.....
58800	22732	" Guiding Roller (front of arm).....
122898	22732	" " " Cover.....
1042C	22732	" " " Screw.....
122869	22750	" Take-up Cam with 432C.....
8983	22734	" " " Pin.....
432C	22734	" " " Set Screw.....
122870	22738	" " Lever.....
122871	-----	Thread Take-up Lever complete, Nos. 164D, 51826, 122870, 122872, 122898, 122899 and two each 1042C and 58800.....
50273C	22734	Thread Take-up Lever Hinge Screw.....
51826	22734	" " " Roller and Screw Stud with 1608C.....
1608C	22734	Thread Take-up Lever Roller and Screw Stud Nut.....
122872	22734	Thread Take-up Lever Thread Guide.....
164D	22734	" " " " " Screw..
58800	22732	" " " " " Guiding Roller (back).....
122899	22734	Thread Take-up Lever Thread Guiding Roller (back) Cover.....
1042C	22732	Thread Take-up Lever Thread Guiding Roller (back) Cover Screw.....
58800	22732	Thread Take-up Lever Thread Guiding Roller (front).....

No.	Plate	Name
122898	22732	Thread Take-up Lever Thread Guiding Roller (front) Cover.....
1042C	22732	Thread Take-up Lever Thread Guiding Roller (front) Cover Screw.....
58886	22734	Thread Take-up Spring.....
122904	22744	Throat Plate for 122905.....
122905	-----	" " 122904 with 219D and 122876, for 122764.....
122876	22734	Throat Plate Edge Guide.....
219D	22734	" " " " Screw.....
122906	22744	" " Extension.....
159D	22734	" " " Screw.....
159D	22734	" " " Screw.....
*15404	-----	Trade Mark.....
15405	-----	" " Rivet.....
122877	22753	Vibrating Presser Bar.....
122878	22753	" " " Eccentric with 436C and 832C.....
832C	22727	Vibrating Presser Bar Eccentric Position Screw.....
436C	22727	Vibrating Presser Bar Eccentric Set Screw
122879	22730	" " " Extension.....
122886	22730	" " " Guide.....
122887	22730	" " " Bracket.....
1186C	22727	" " " " " Screw.
704C	22757	" " " " " Screw.....
122880	22730	" " " " " Stud.....
122881	22742	" " " " " Lifter.....
1201D	22730	" " " " " Hinge Screw..
122882	22730	" " " " " Stop.....
122883	22730	" " " " " " Plate with 122882.....
1186D	22727	Vibrating Presser Bar Lifter Stop Plate Screw.....
122884	22742	Vibrating Presser Bar Lifting Link.....
51156D	22730	" " " " " Hinge Screw.....
1650R	22730	Vibrating Presser Bar Lifting Link Hinge Screw Nut.....
964D	22730	Vibrating Presser Bar Lifting Link Screw.
122885	22733	" " " " " " " " Block with 363C.....
363C	22733	Vibrating Presser Bar Lifting Link Screw Block Set Screw.....
50484C	22733	Vibrating Presser Bar Regulating Screw Stud.....
1513J	22728	Vibrating Presser Bar Regulating Screw Stud Nut.....
122779	22726	Vibrating Presser Bar Regulating Screw Stud Sleeve.....

No.	Plate	Name
58715	22726	Vibrating Presser Bar Regulating Screw Stud Washer.....
122888	22742	Vibrating Presser Bar Regulator with 363C
128889	22742	" " " " Connection
61587	22726	" " " " Pin.....
363C	22733	" " " " Set Screw.
122890	22753	" " " " Shaft....
122891	22742	" " " " " Con- necting Link.....
866D	22726	Vibrating Presser Bar Regulator Shaft Connecting Link Hinge Screw.....
122892	22753	Vibrating Presser Bar Spring (flat).....
122893	22742	" " " " Bracket....
1062E	22733	" " " " " Screw
4389	22733	" " " " Stud.....
122894	22742	" " " Foot with two 1396D....
1396D	22727	" " " Clamping Screw....

Genuine Singer Needles should be used
in Singer Machines.
These Needles and their Containers
are marked with the
Company's Trade Mark "SIMANCO." 1

Needles in Containers marked
"For Singer Machines"
are not Singer made needles. 2

MACHINE No. 122-2

For Joining Press Cloths Made of Camel's Hair, for Straining
Cotton Seed Oil. Needle and shuttle vibrate simultaneously.
Throw of needle one inch each side of center; makes a zigzag
line of three stitches of 5/8 inch each. Has 4 inch cylinder shuttle
No. 122835, upper and under feeds and alternating pressers.
Lift of presser foot 3/4 inch. Has S. D. A. Speed 300 R. P. M.

NOTE: THIS MACHINE IS THE SAME AS THE 122-1 MACHINE,
WITH THE FOLLOWING EXCEPTIONS:

No.	Plate	Name
122925	22750	Arm Shaft, in place of 122752.....
51230D	22757	" " Screw, in place of 50262D.....
64041	22752	Balance Wheel, 8 in. pulley with two 344C in place of 122752.....

DRIVING ATTACHMENT

FOR I22-2 MACHINE

No.	Plate	Name
64042	-----	Balance Wheel 64041 with 8987, 64046, two 1445E and four 401E.....
25362	22736	Balance Wheel Ball, size 3/16 in.....
64043	-----	" " " Ring.....
64044	22746	" " " " 64043 with twenty-seven 25362.....
64045	22746	Balance Wheel Ball Washer (left).....
64046	22746	" " " " (right).....
1445E	22736	" " " " " Screw...
344C	22736	" " " " " Set Screw.....
8984	22746	Brake Block (wood).....
58458	22736	" " Stud.....
1036C	22736	" " " " " Set Screw.....
8985	22750	Friction Pulley with 8986.....
8986	22746	" " " " " Center Bearing.....
8987	22754	" " " " " Washer (paper).....
401E	22736	" " " " " Screw.....
64070	22760	Lever with 1036C.....
122929	22750	" " Bracket.....
839E	22736	" " " " " Bolt (long) with 1522E.....
497E	22736	" " " " " (short) with 1522E.....
1522E	22736	" " " " " Nut.....
134D	22734	" " " " " Screw.....
8991	22746	" " " " " Washer.....
8992	22746	" " " " " Spring.....
122920	22736	" " " " " Hook.....
134D	22734	" " " " " Screw.....
9091	22754	Shaft Driving Pulley, 10 in. diam., 1-1/2 in. face, 1-3/16 in. bore (sectional) with two 597C.....
597C	22736	Shaft Driving Pulley Clamping Screw.....
126036	22754	Treadle.....
126205	22746	" " Bracket (left).....
126206	22746	Treadle Bracket (left) complete, Nos. 23258 126205, 126207, 126208 and two wood screws 1 in. No. 14.....
126207	22746	Treadle Bracket (left) Hook.....
23258	22746	" " " " " Friction Washer.....
126208	22746	Treadle Bracket (left) Hook Rivet.....
46681	22746	" " " " " (right).....
60502	-----	" " " " " 46681 with two wood screws 1 in. No. 14.....
27637	22756	Treadle Pitman Rod (lower).....
150208	22733	" " " " " Spring.....

No.	Plate	Name
6055	22736	Treadle Pitman Rod (lower) Spring Washer.
27639	22746	" " " " (upper).....
80223	22736	" " " " " Clamp with 361C.....
361C	22736	" " " " " Screw.....
27640	-----	Treadle Pitman complete, Nos. 2762, 6055, 27637, 27639, 80223 and 150208.....
2762	22736	Treadle Stop Collar with 362C.....
362C	22736	" " " " " Set Screw.....
126209	-----	Treadle complete, Nos. 60502, 126036 and 126206.....
126210	-----	Treadle and Pitman complete, Nos. 27640 and 126209.....
122921	-----	Driving Attachment complete, Nos. 497E, 839E, 8984, 8985, 8991, 8992, 9091, 58458, 54042, 64044, 64045, 64070, 122920, 122929, 126210 and two 134D.....

Genuine Singer Needles should be used
in Singer Machines.
These Needles and their Containers
are marked with the
Company's Trade Mark "SIMANCO." 1

Needles in Containers marked
"For Singer Machines"
are not Singer made needles. 2

ACCESSORIES

No.	Plate	Name
120346	22755	Oiler (copper plated) with 120347.....
120347	22755	" Spout, 9 in. long.....
11831	22755	Screw Driver (large).....
26026	22755	" " (small).....
8909	22755	Wrench for 1513.....
23766	22755	" " 1583.....
58844	22755	" " 1517 and 1736.....

BOBBIN WINDER

(SWINGING AUTOMATIC, RIGHT HAND)

FOR FLAT OR ROUND BELT

No.	Plate	Name
41550	22747	Base with 458C, 27916 and two 28084.....
41551	22737	Bobbin Position Pin.....
27916	22747	Brake (leather).....
28084	22747	" Rivet.....
41440	22747	Frame.....
41441	22747	" Hinge Pin.....
458C	22737	" " " Set Screw.....
4784	22737	" Oil Pad.....
41442	22747	" Spring.....
41443	22747	Pulley with 155C.....
155C	22737	" Set Screw.....
41552	22747	Spindle.....
41553	22737	" Collar with 41551 and two 449C....
449C	22737	" " Set Screw.....
41554	22747	Stop Latch.....
11107	22747	" " Hinge Pin.....
2269	22737	" " Pin.....
41447	22747	Tripping Arm with 176D.....
176D	22737	" " Clamping Screw.....
41555	-----	Bobbin Winder, Nos. 2269, 11107, 41440 to 41443, 41447, 41550, 41552 to 41554, two 4784 and three screws 1 in. No. 7

THREAD UNWINDER

(FOR TWO SPOOLS)

No.	Plate	Name
150677	22758	Base with two 138B.....
150678	22758	Rod.....
27560	22758	" (bobbin winder).....
138B	22757	" Set Screw.....
150679	22758	Spool Disc.....
9241	22758	" " Spring.....
41450	-----	" Rest.....
41451	22758	" " 41450 with 138E and 27555 (bobbin winder).....
138E	22757	Spool Rest Set Screw.....
27555	22758	" " Spool Pin.....
150682	-----	Tension Bracket and Thread Guide with 177C.....
150683	22758	Tension Bracket and Thread Guide 150682 with 10148, 42418, 49220 and two 2102
177C	22757	Tension Bracket and Thread Guide Set Screw.....
2102	22757	Tension Disc.....
1560C	22757	" Regulating Thumb Nut.....
828C	22757	" Screw Stud.....
42418	-----	" " " 828C with 1560C.....
10148	22757	" Spring.....
49220	-----	" Thread Guide.....
150680	22758	Thread Guide.....
150681	22758	" " Bracket with 177C and 736J..
736J	22757	" " " Thumb Screw.....
177C	22757	" " Set Screw.....
150684	22758	Thread Unwinder complete, for two spools, Nos. 9241, 27560, 41451, 150677, 150678, 150680, 150681, 150683 and two 150679 and three wood screws 1 in. No. 12.....

OBSOLETE PARTS

No.	Plate	Name
60401	22759	Base with two 446C.....
41556	-----	Bobbin Winder (swinging automatic, right hand) complete, Nos. 41454 and 41555.
122762	22756	Feed Bar with 447C.....

OBSOLETE PARTS

No.	Plate	Name
122766	22756	Feed Fork Connection with 1396D, use 122934.....
604C	22726	Feed Fork Connection Slide Block Screw...
1396D	22727	" " " " " "
		Clamping Screw.....
11367	22747	" Lifting Cam with two 445C, use 122909
122794	22747	Needle Bar.....
122795	-----	" " and Shuttle Race Vibrating Arm with 429C and 122896, superseded by 122931, not interchangeable.....
429C	22737	Needle Bar and Shuttle Race Vibrating Arm Set Screw.....
866D	22726	Needle Bar Indicating Segment Slide Block Hinge Screw, use 50601.....
122827	22747	Needle Bar Vibrating Cam Gear Shaft Collar with two 858C, use 122783.....
122828	22737	Needle Clamp with 680D and 11385.....
11385	-----	" " Gib.....
680D	22737	" " " Thumb Screw.....
27724	22759	Rod.....
446C	22737	" Set Screw.....
135D	22737	Shuttle Race Cap Screw.....
27557	22759	Spool Stand with 138D.....
41514	22759	" Weight, 4 in. diam., with 41515....
41515	-----	" " Center Pin.....
50271C	22757	Tension (under) Screw Stud.....
2103	22757	" Spring.....
5769	-----	" Thread Eyelet.....
17547	-----	" " Guide.....
58795	22748	" (under) Wheel.....
58796	-----	Tension (under) Wheel complete, Nos. 1535E 8787, 19684, 19686, 50271C, 58795 and two 11241.....
122861	22748	Thread (under) Carrier Regulator with 51840.....
122863	22748	Thread (under) Carrier Regulator Shaft...
1177D	22737	" " " Screw.....
60608	-----	" Guide.....
60203	22759	" " Cone.....
60402	22759	" " Holder with 447C and two 286D.....
286D	22737	Thread Guide Holder Thumb Screw.....
447C	22727	" " Set Screw.....
33CE	22737	" " " ".....
60609	22759	Thread Guide complete, Nos. 330E, 2103, 5769, 17547, 42418, 60608 and two 2102.....
122900	22737	Thread Take-up Lever Thread Guiding Roller (front) Cover, use 122898.....

OBSOLETE PARTS

No.	Plate	Name
41454	22759	Thread Unwinder complete, for one large spool, Nos. 27557, 27560, 41451, 41514 60609 and three wood screws 1-1/4 in. No. 12.....
60403	22759	Thread Unwinder complete, Nos. 27555, 60203, 60401, 60402 and two each 27724 and wood screws 2 in. No. 10...
122873	22748	Throat Plate for 122874.....
122874	-----	" " 122873 with 219D and 122876, for 122764.....
122875	22748	Throat Plate Extension.....
63D	22737	Vibrating Presser Bar Lifting Link Hinge Screw, use 51156.....

Genuine Singer Needles should be used
in Singer Machines.
These Needles and their Containers
are marked with the
Company's Trade Mark "SIMANCO." 1

Needles in Containers marked
"For Singer Machines"
are not Singer made needles. 2

PLATE 22726 - FULL SIZE

50272



802



949



604



8055



61587



129



1448



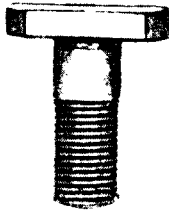
9219



858



50478



122779



1983



866



122896



150



58715



1517



122799



PLATE 22727 - FULL SIZE

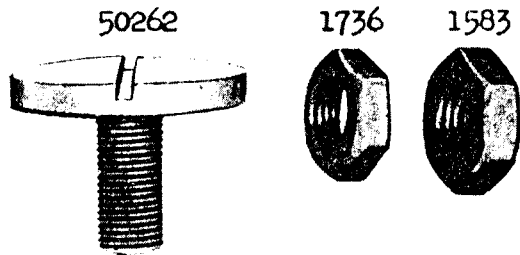
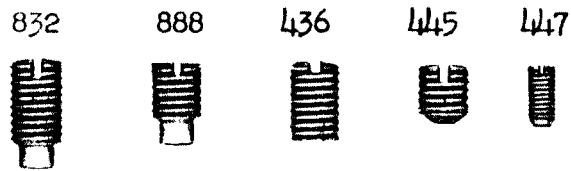
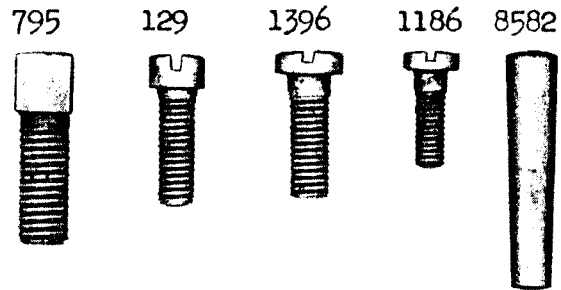
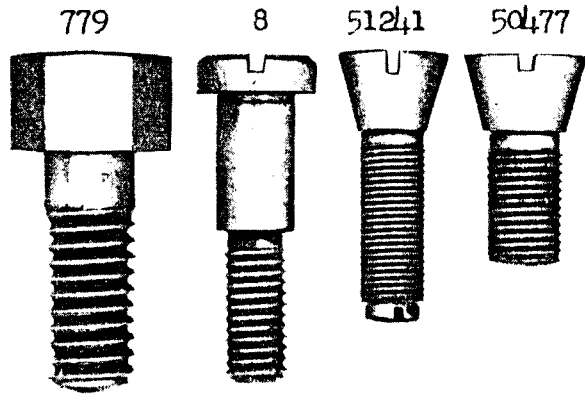


PLATE 22728 - FULL SIZE

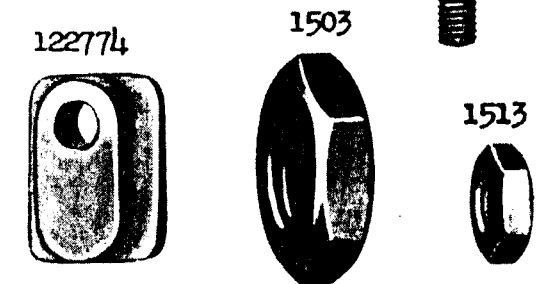
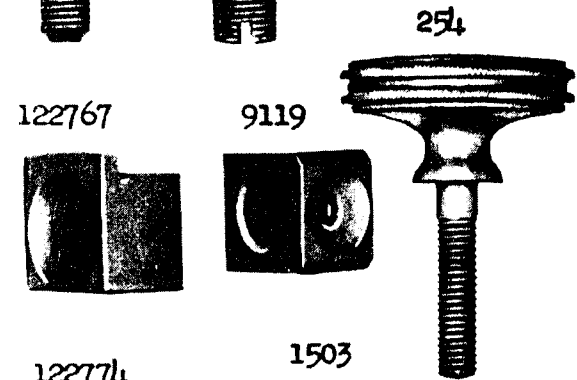
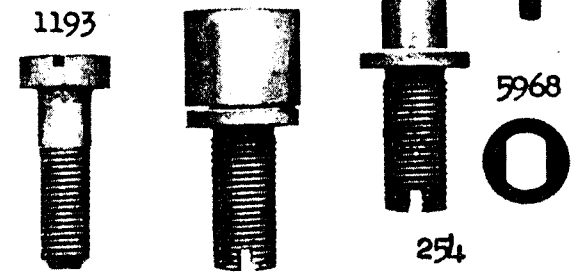
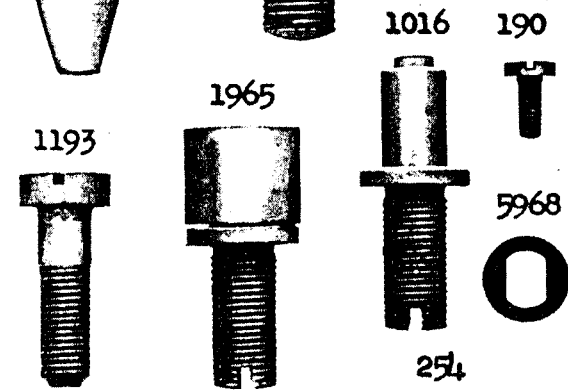
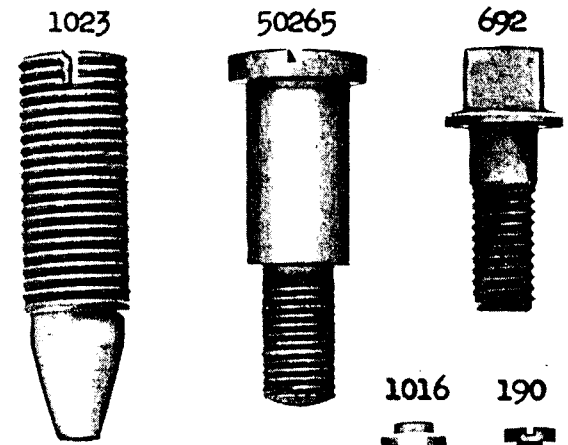


PLATE 22729 - FULL SIZE

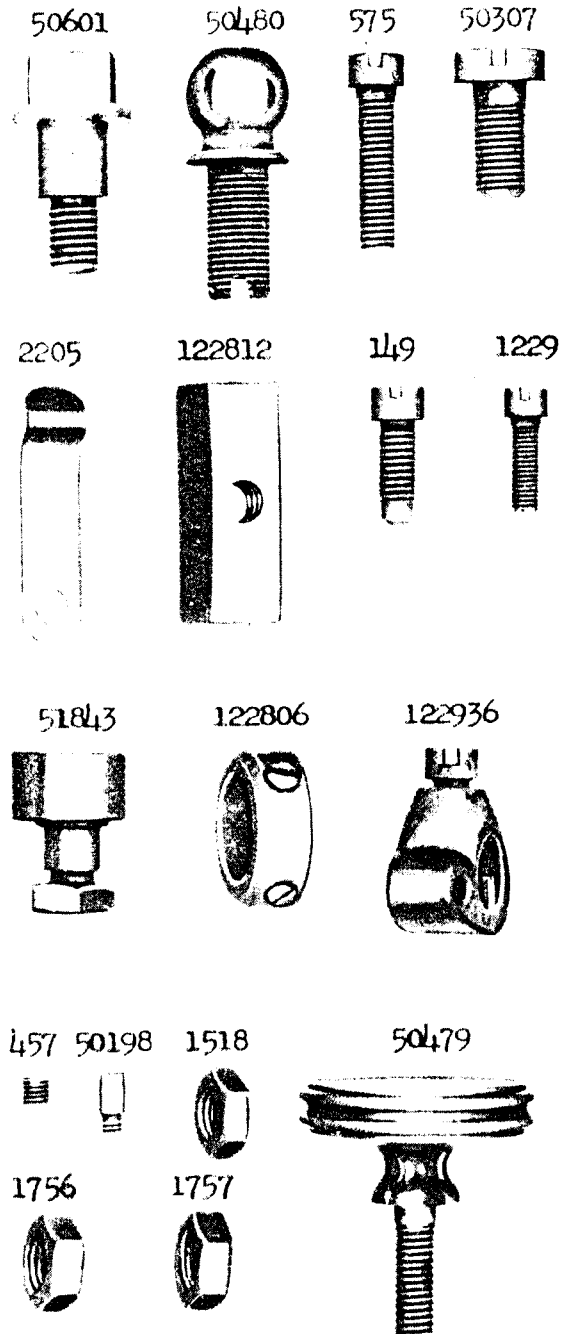


PLATE 22730 - FULL SIZE

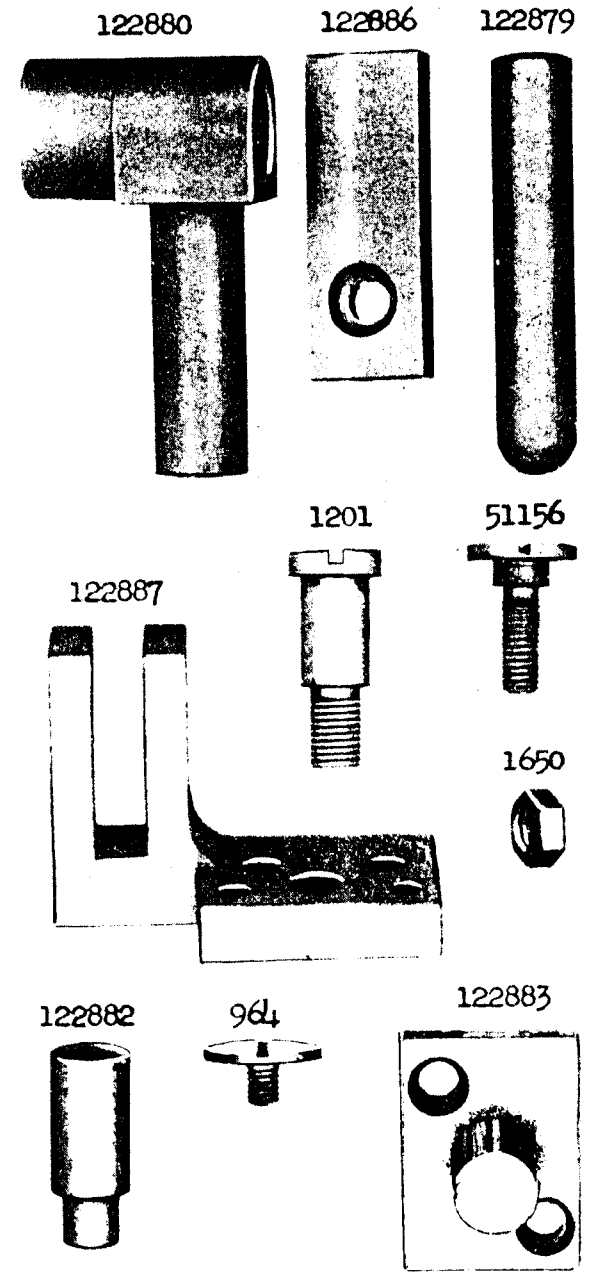


PLATE 22731 - FULL SIZE

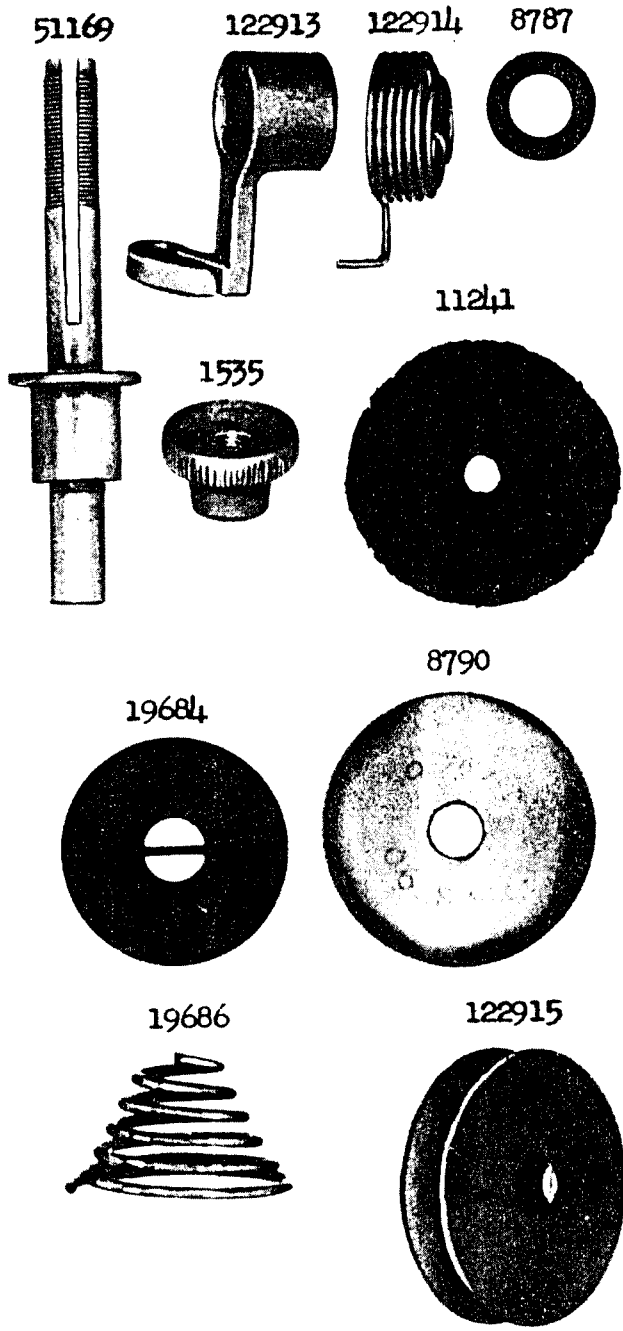


PLATE 22732 - FULL SIZE

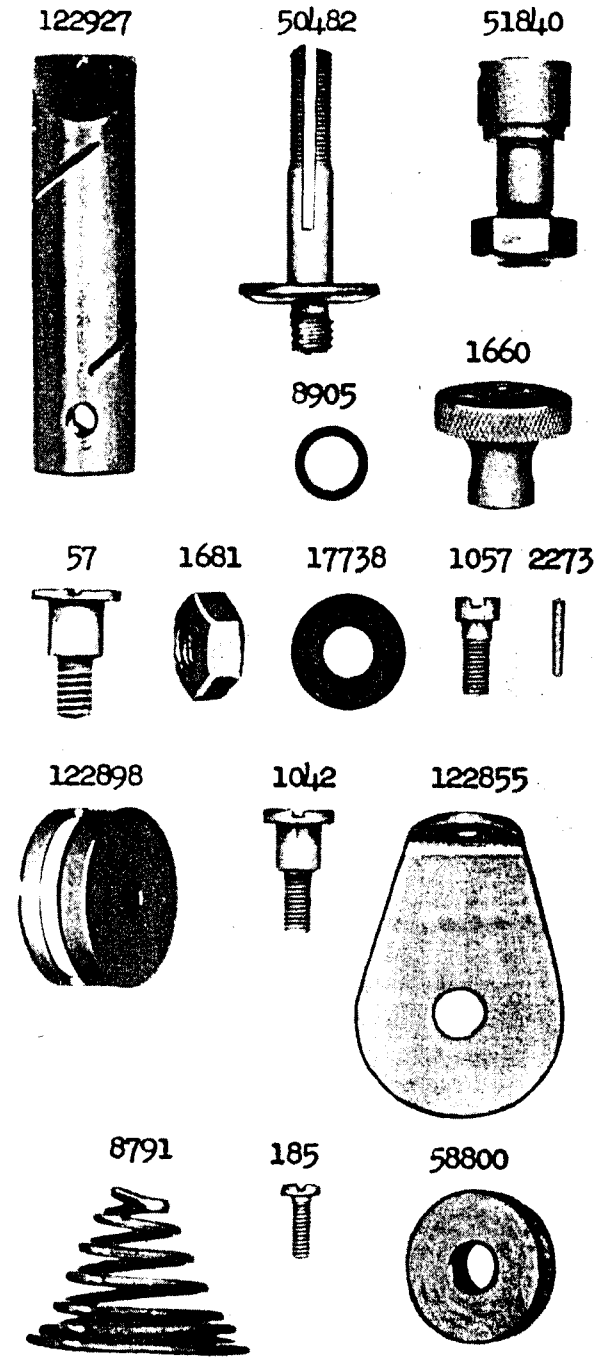


PLATE 22733 - FULL SIZE

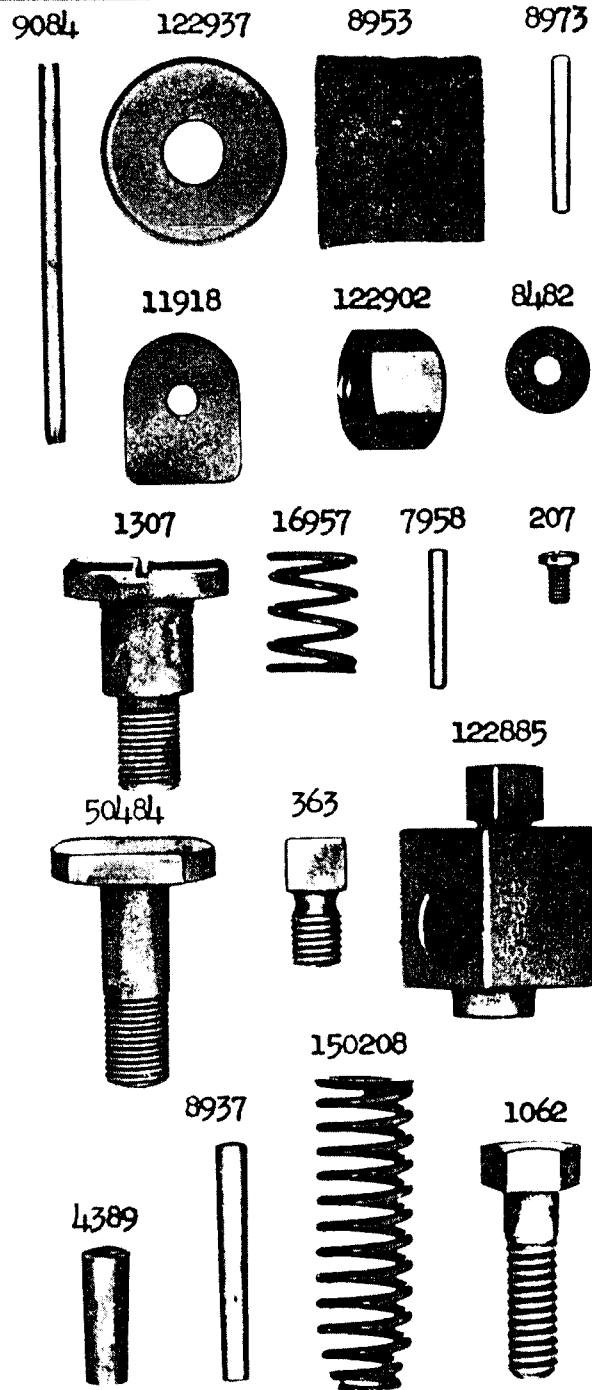


PLATE 22734 - FULL SIZE

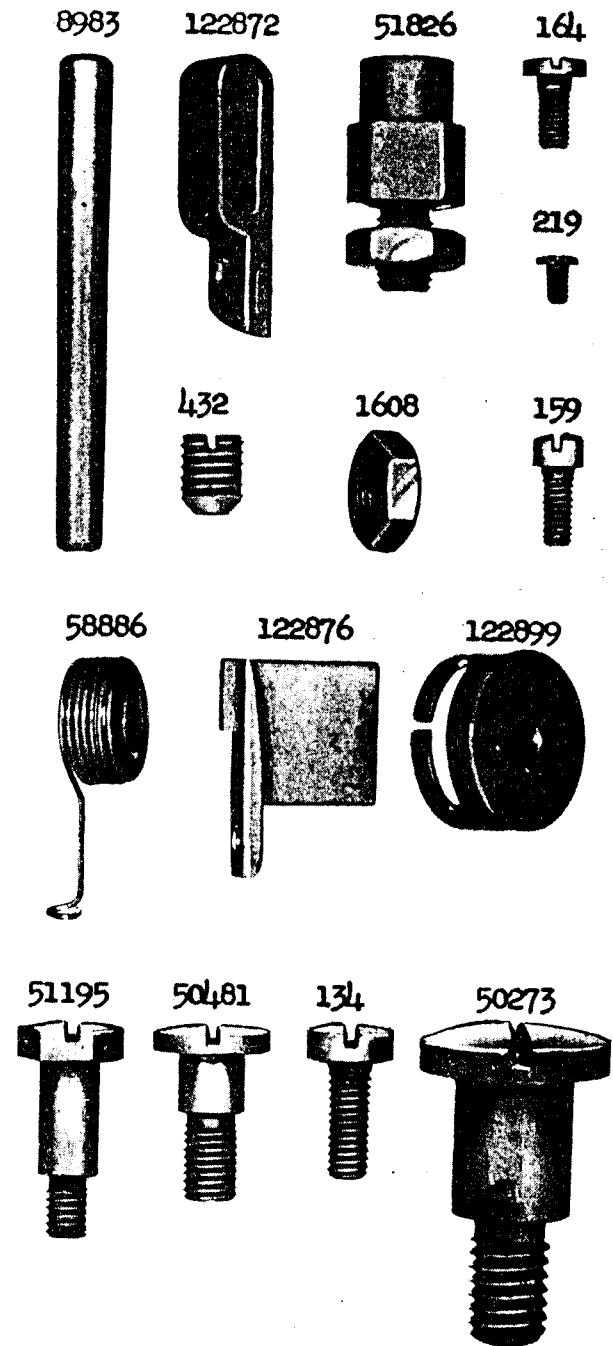


PLATE 22735 - FULL SIZE

122907



122908



122917



122910



8777



43236



40025



19869



43235



1916

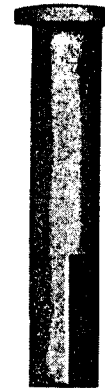


1323

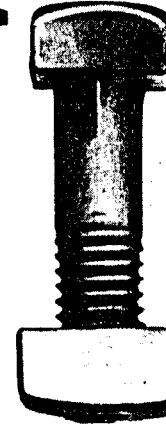


PLATE 22736 - FULL SIZE

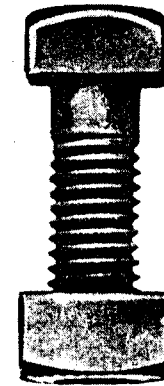
58458



839



497



597



344



361



362



2762



122920



1522



80223



25362



1445



401



1036



6055

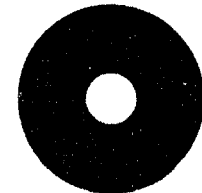


PLATE 22737 - FULL SIZE

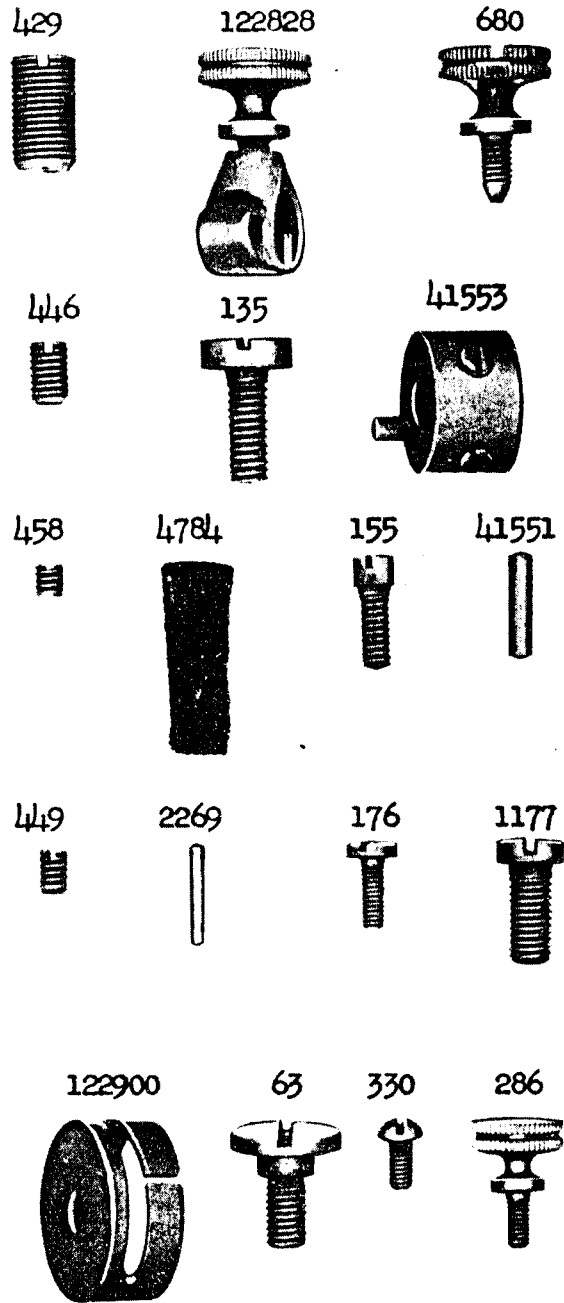


PLATE 22738 - ONE-HALF SIZE

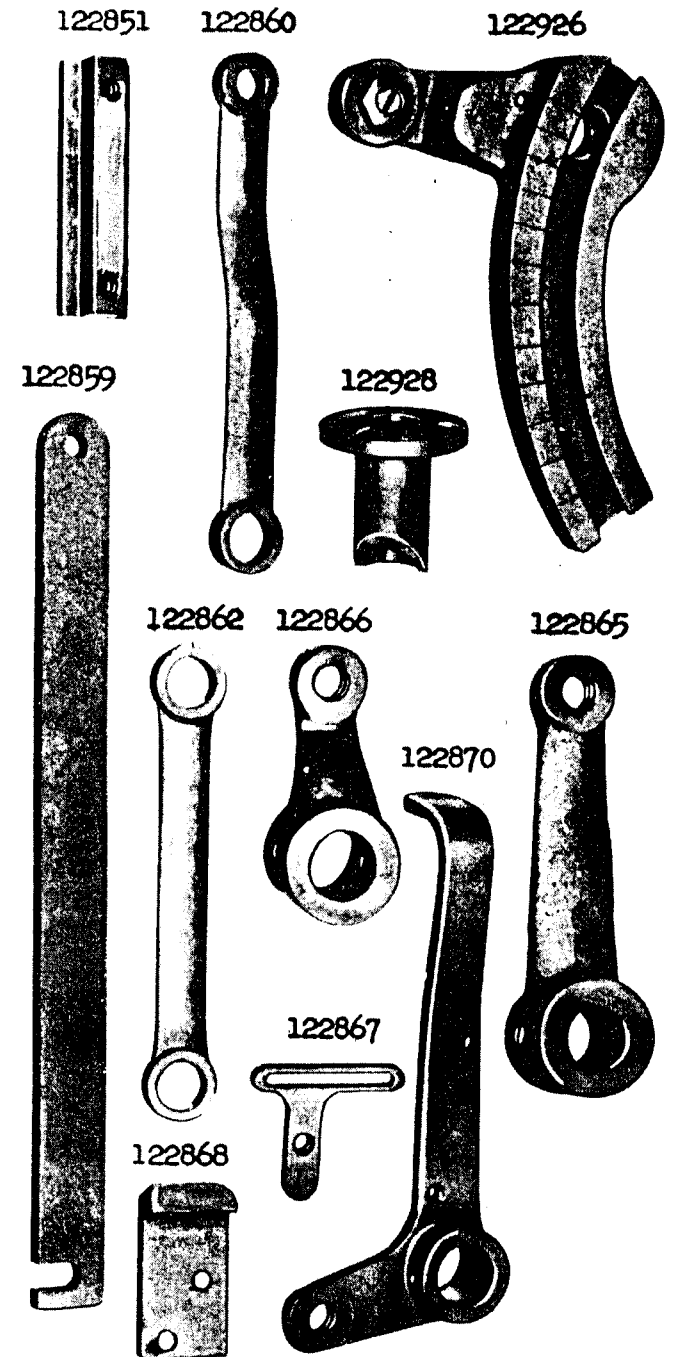


PLATE 22739 - ONE-HALF SIZE

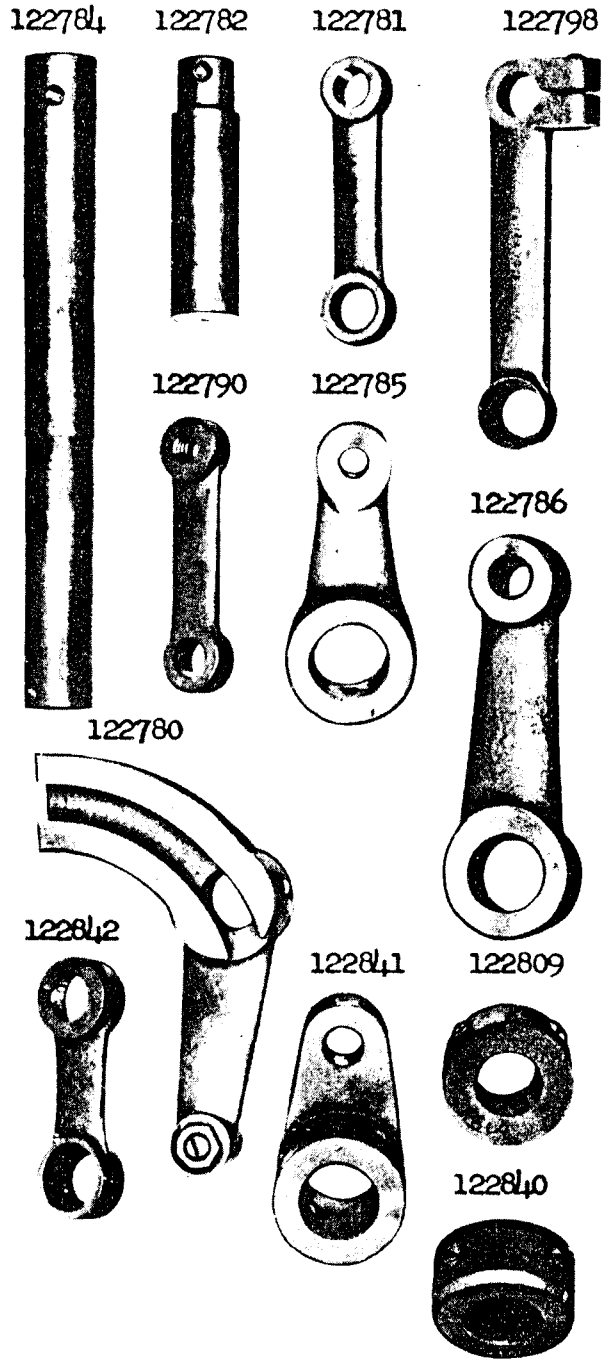


PLATE 22740 - ONE-HALF SIZE

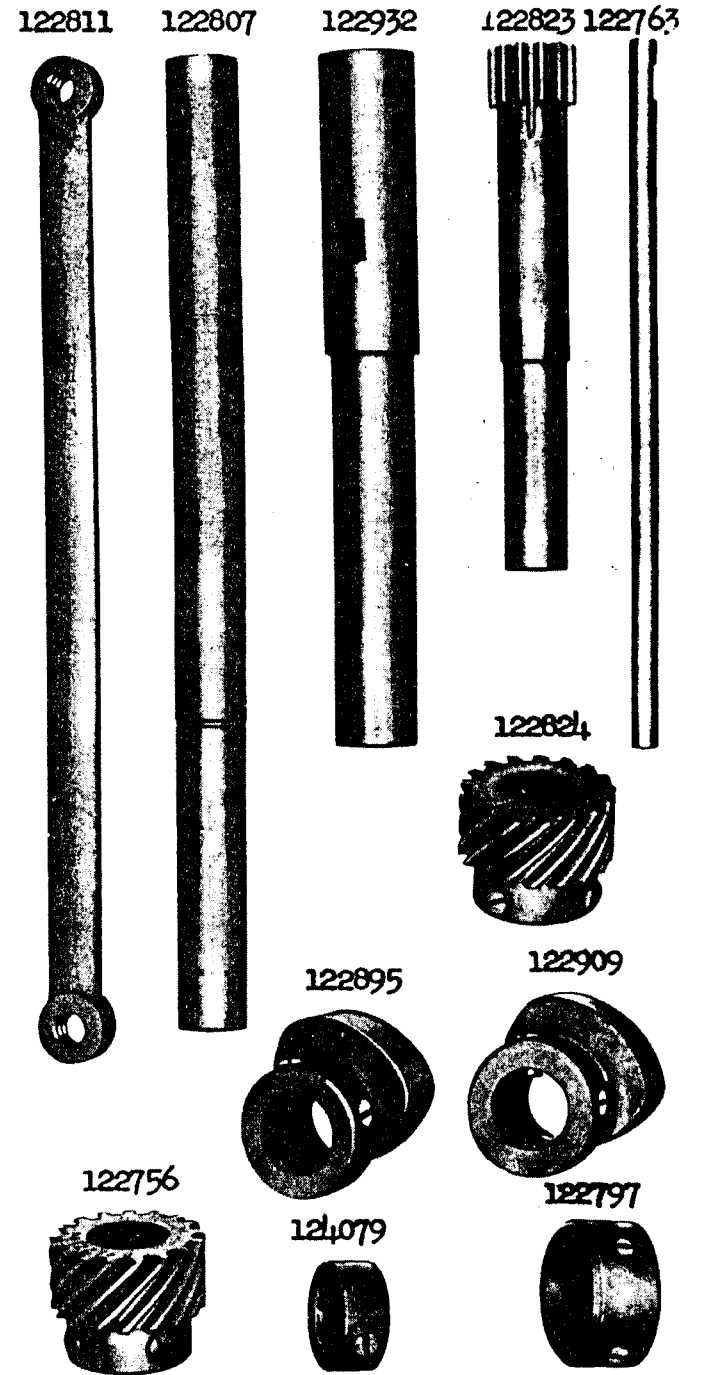


PLATE 22741 - ONE-HALF SIZE

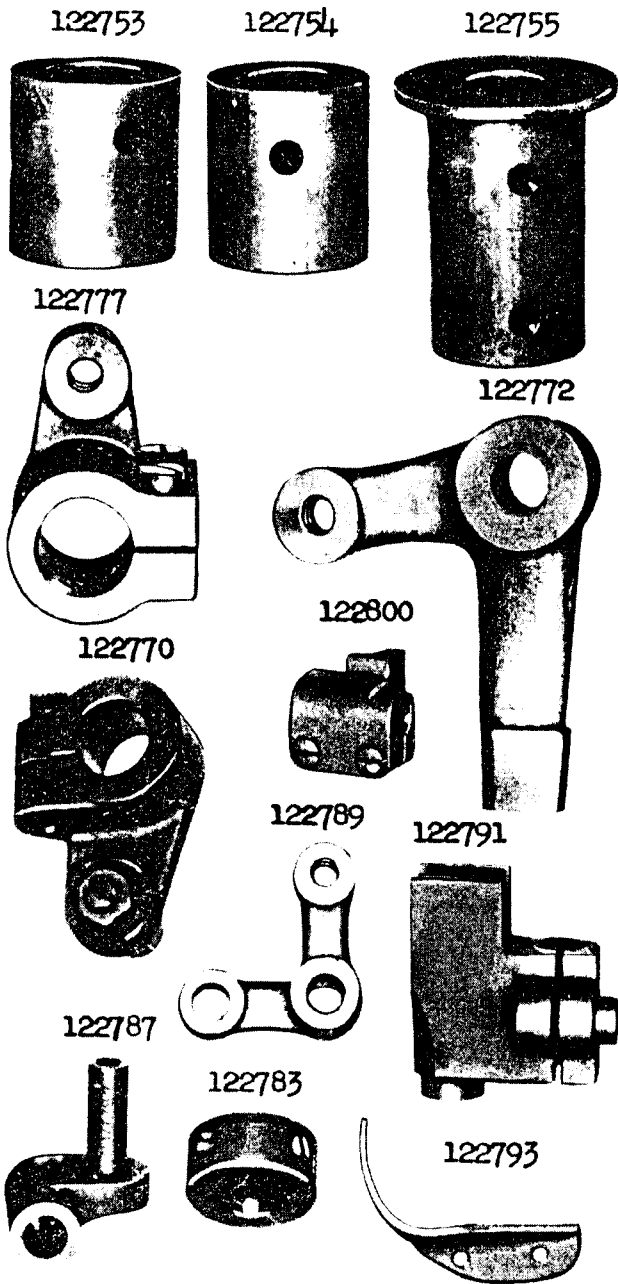


PLATE 22742 - ONE-HALF SIZE

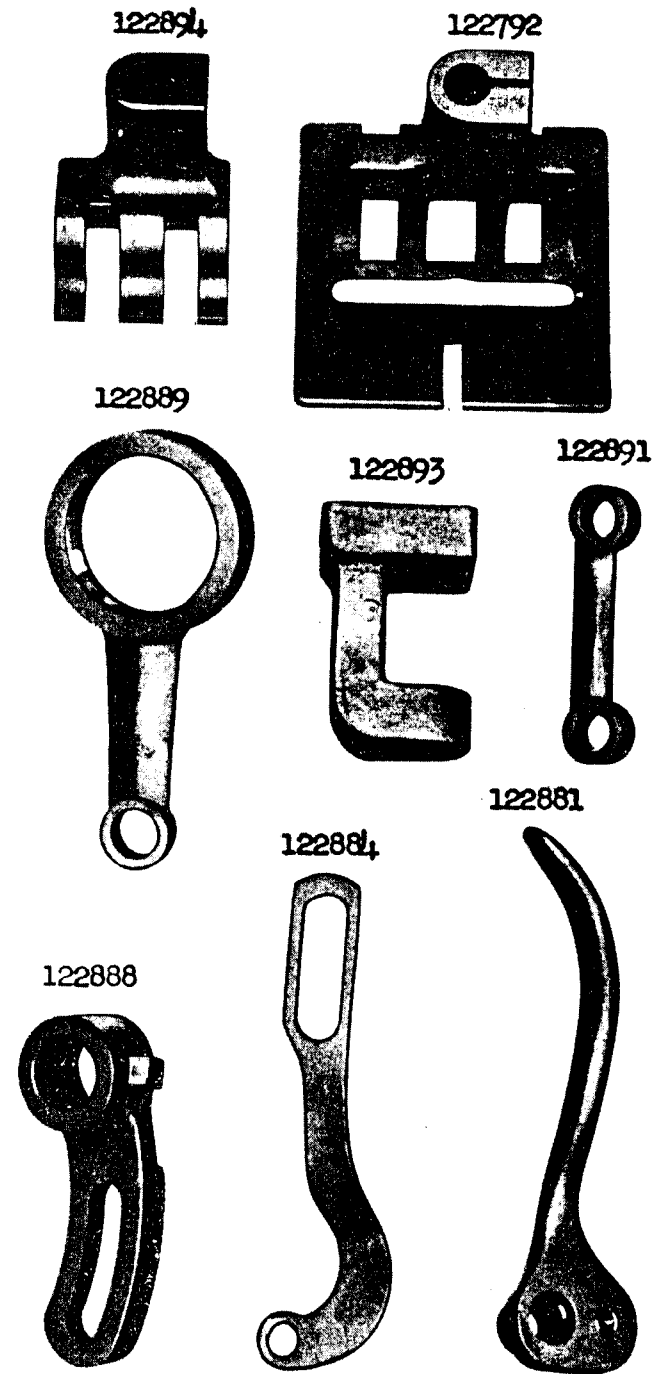


PLATE 22743 - ONE-HALF SIZE

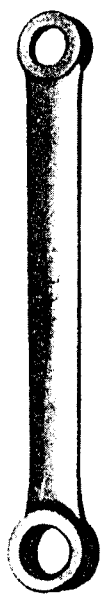
122804



122802



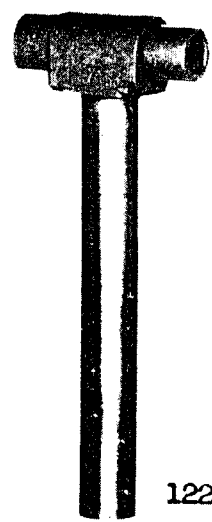
122805



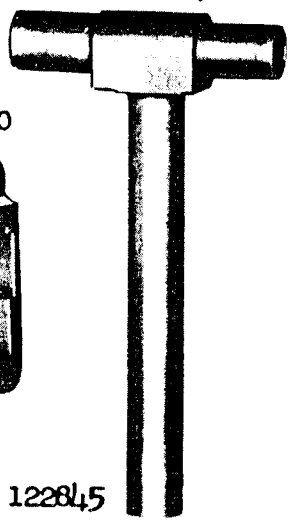
122803



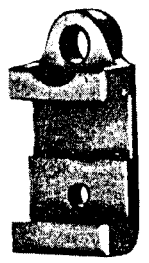
122813



122814



122810



122847



122845

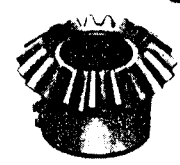
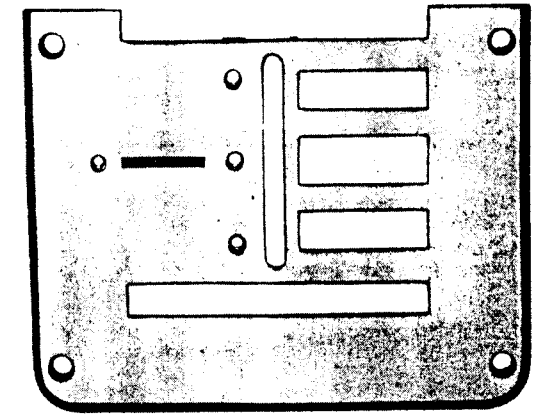
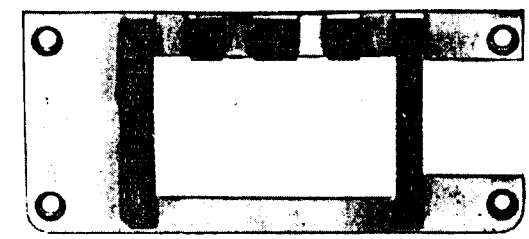


PLATE 22744 - ONE-HALF SIZE

122904



122764



122906



PLATE 22745 - ONE-HALF SIZE

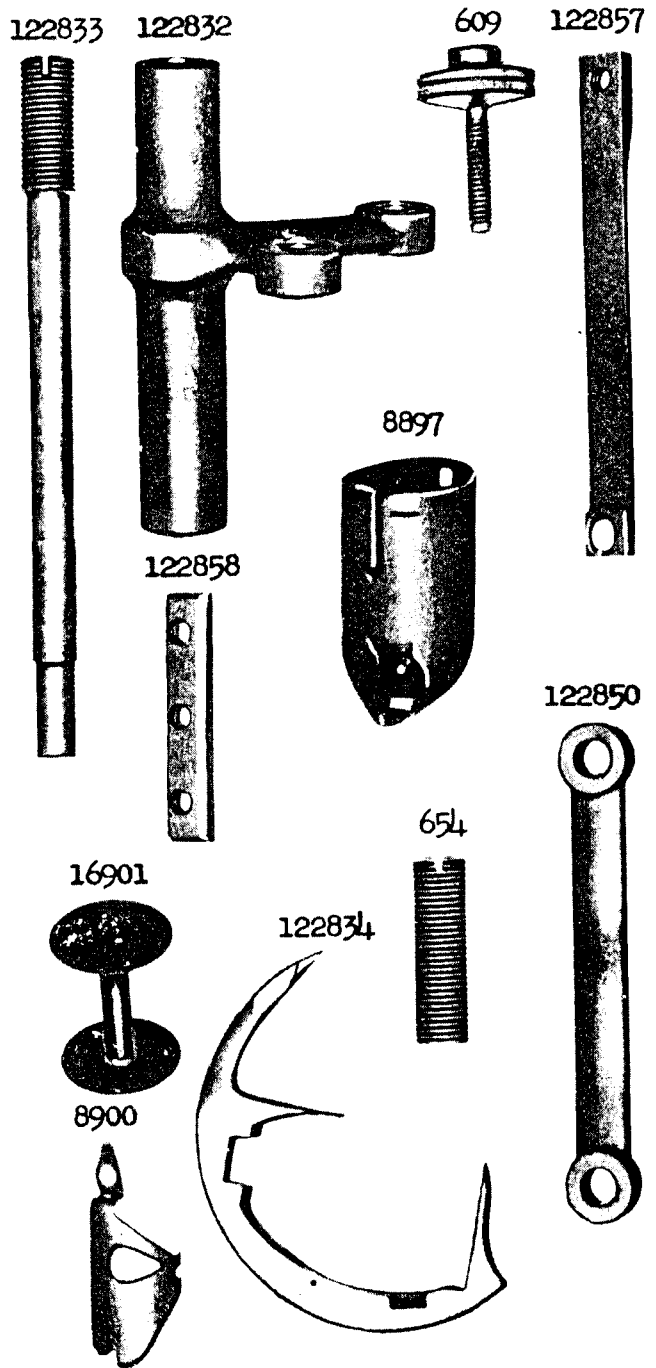


PLATE 22746 - ONE-HALF SIZE

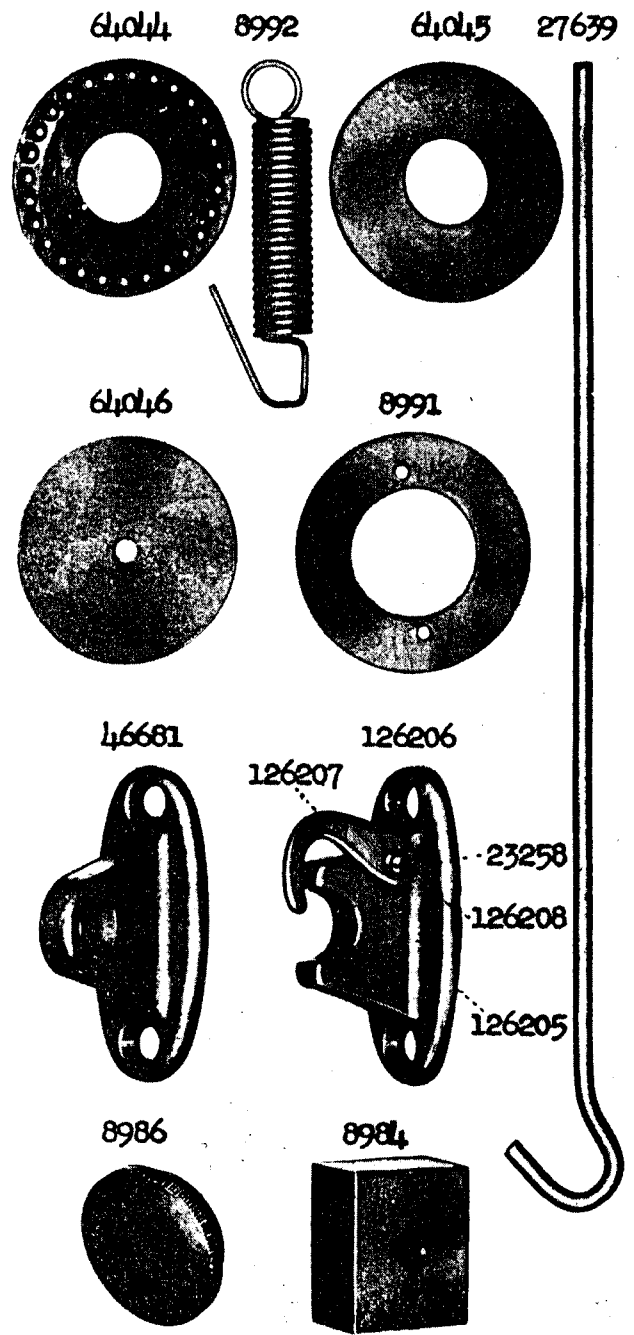


PLATE 22747 - ONE-HALF SIZE

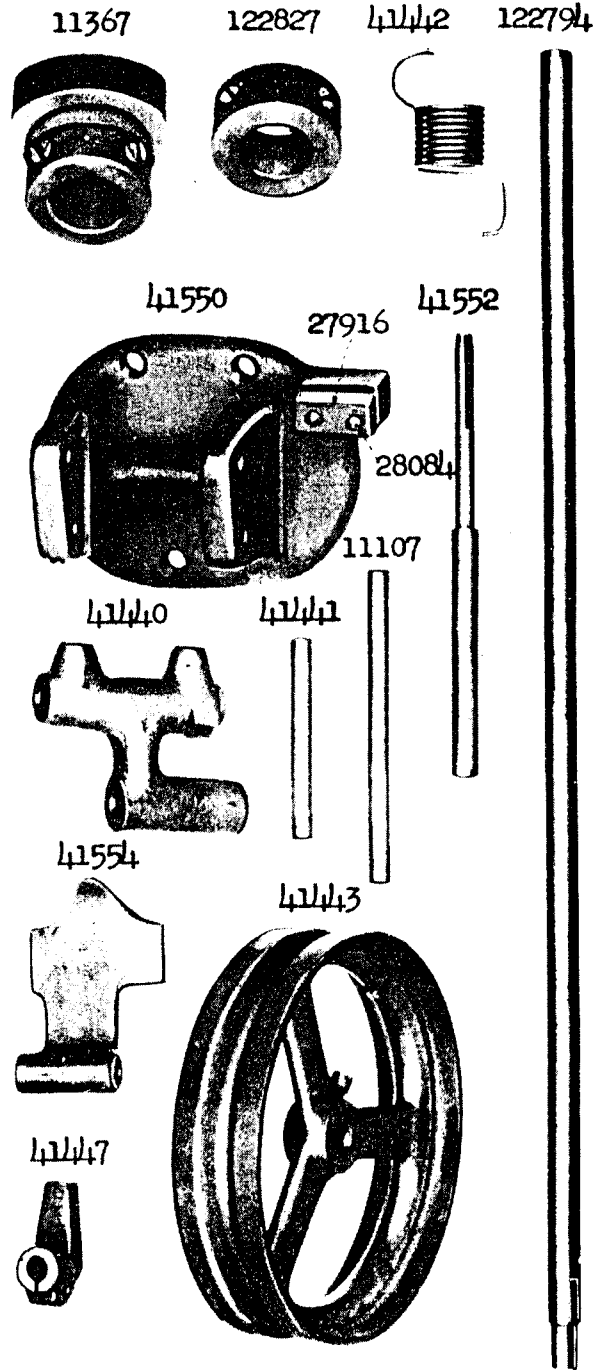


PLATE 22748 - ONE-HALF SIZE

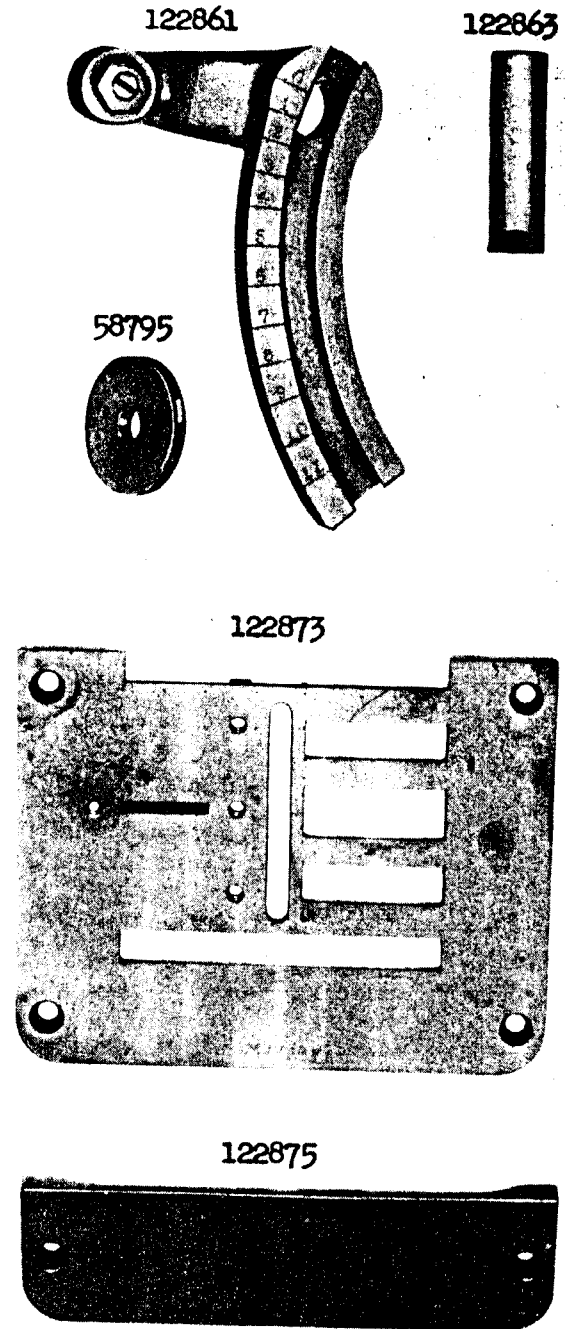


PLATE 22749 - ONE-FOURTH SIZE

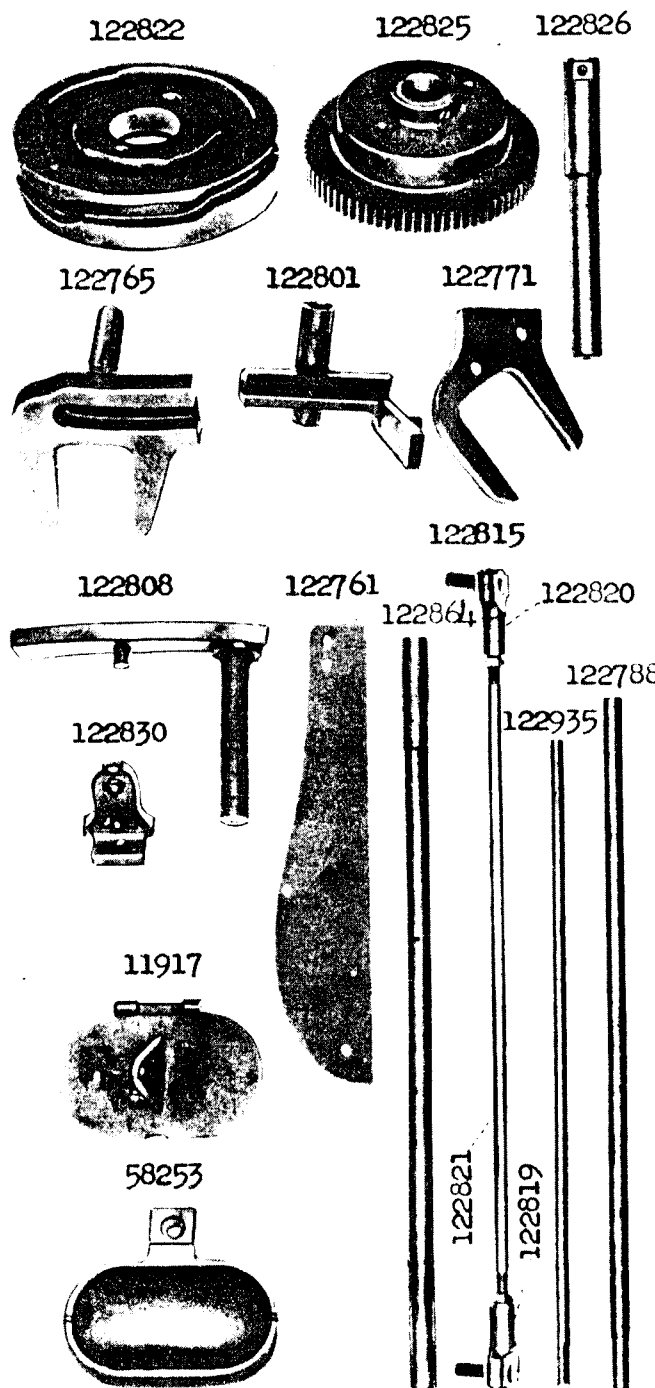


PLATE 22750 - ONE-FOURTH SIZE

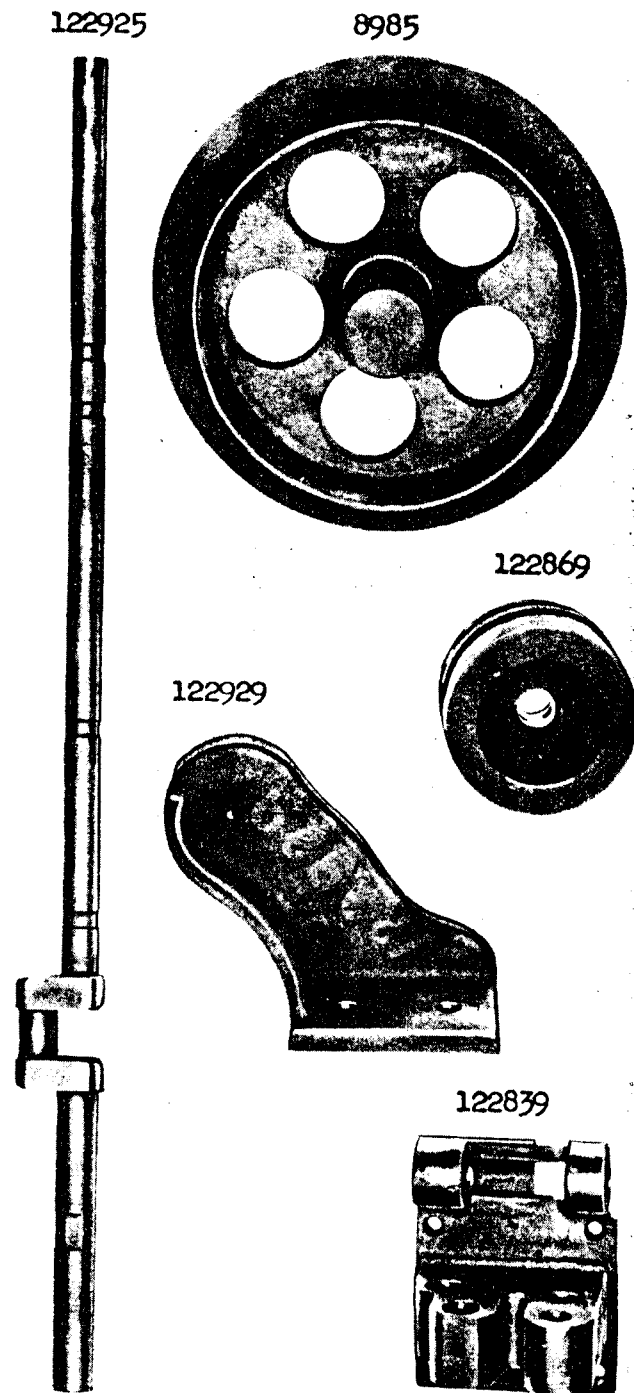


PLATE 22751 - ONE-FOURTH SIZE

122752 122759 122931 122768 122775 122934

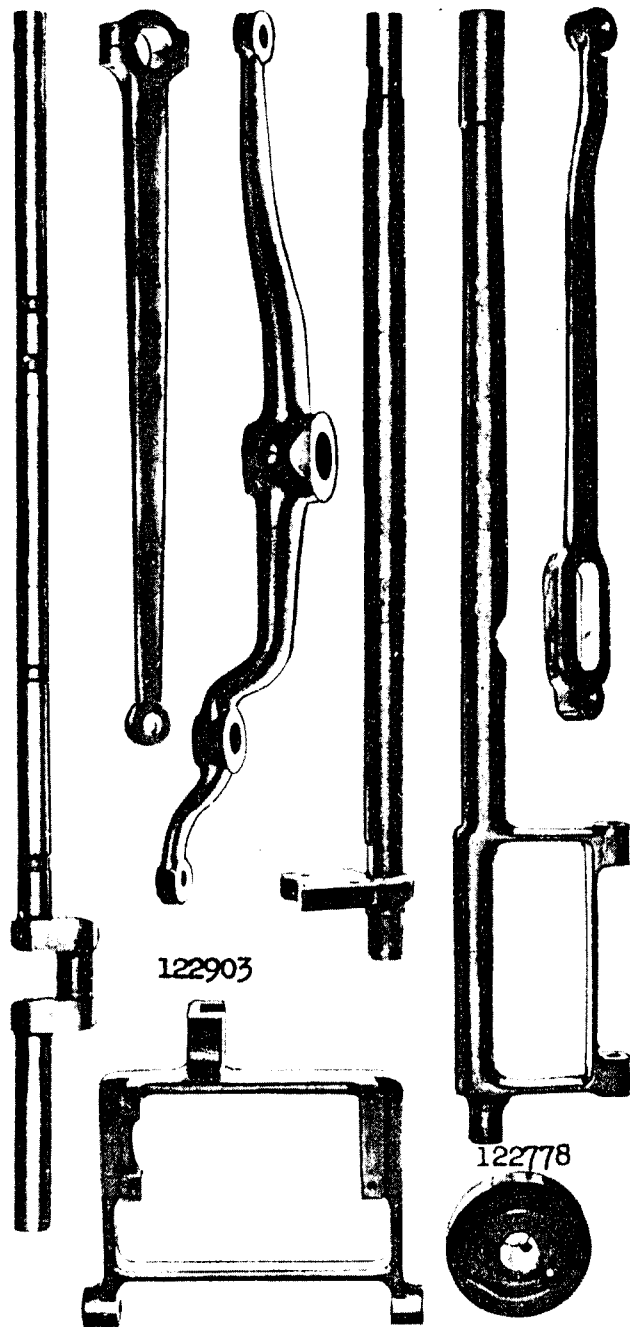
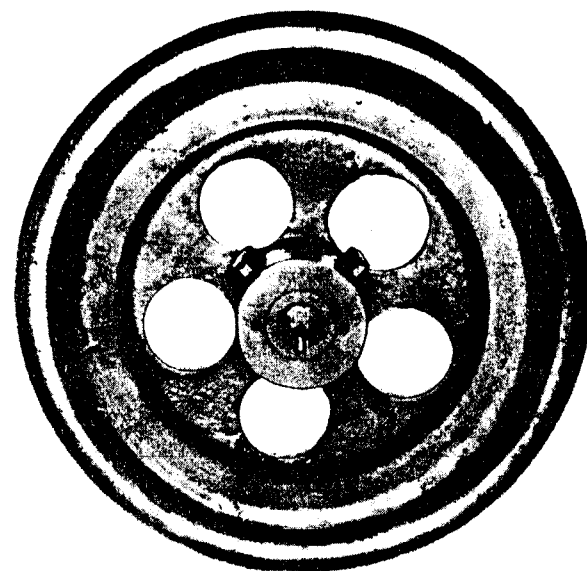


PLATE 22752 - ONE-FOURTH SIZE

64041



122757

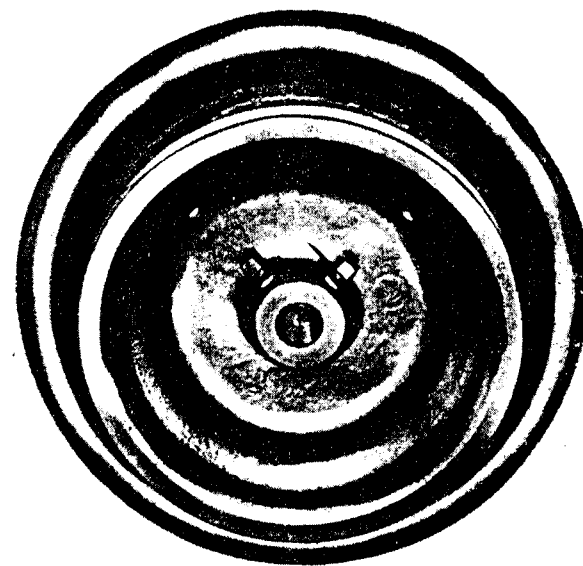


PLATE 22753 - ONE-FOURTH SIZE

122892 122852 122854 122838 122877 122846

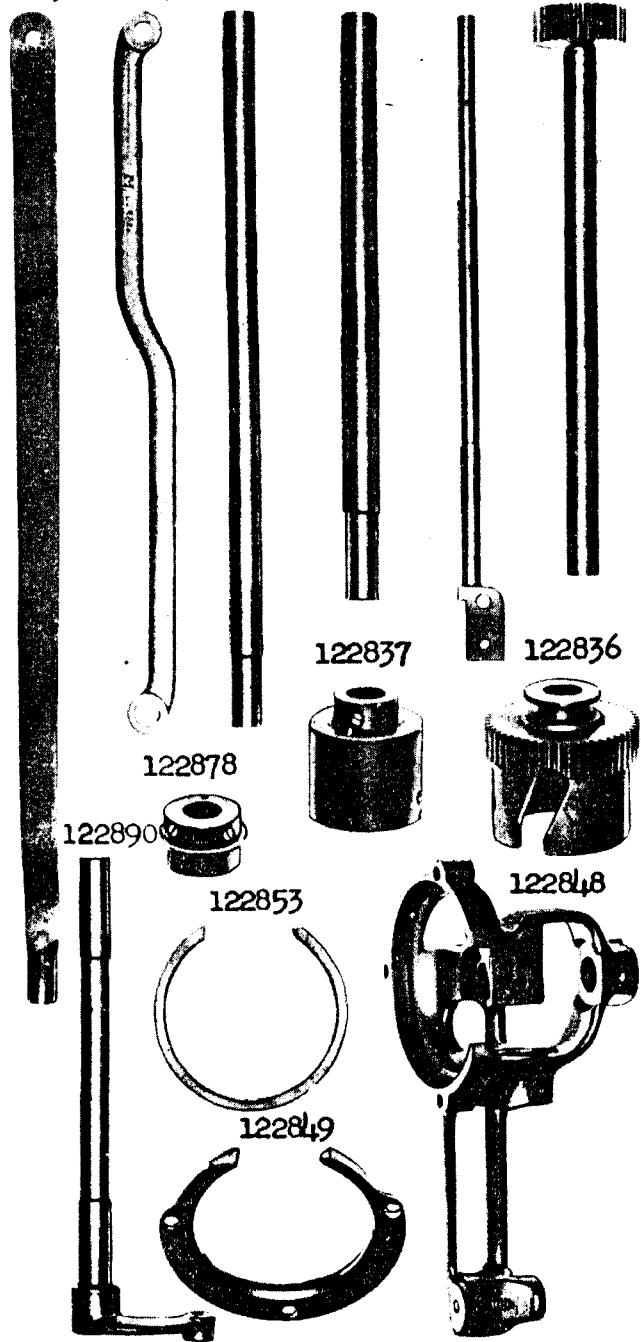


PLATE 22754 - ONE-FOURTH SIZE

126036

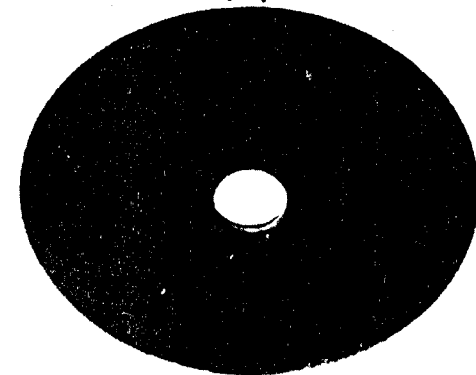
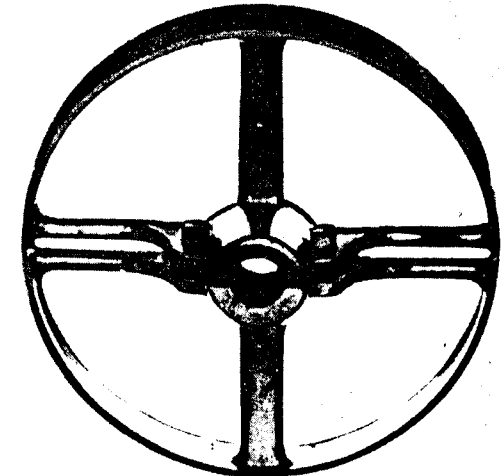
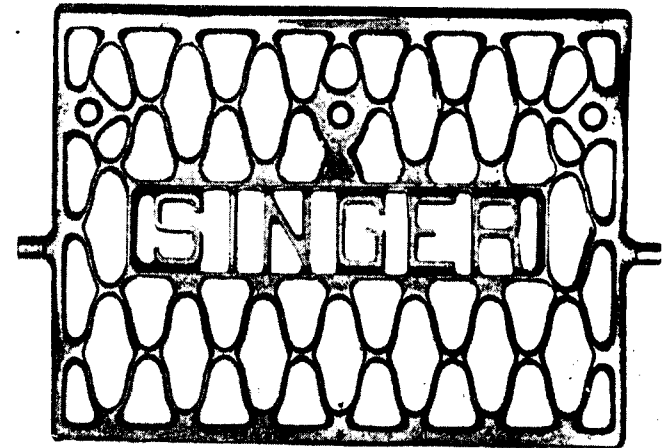


PLATE 22755 - ONE-HALF SIZE

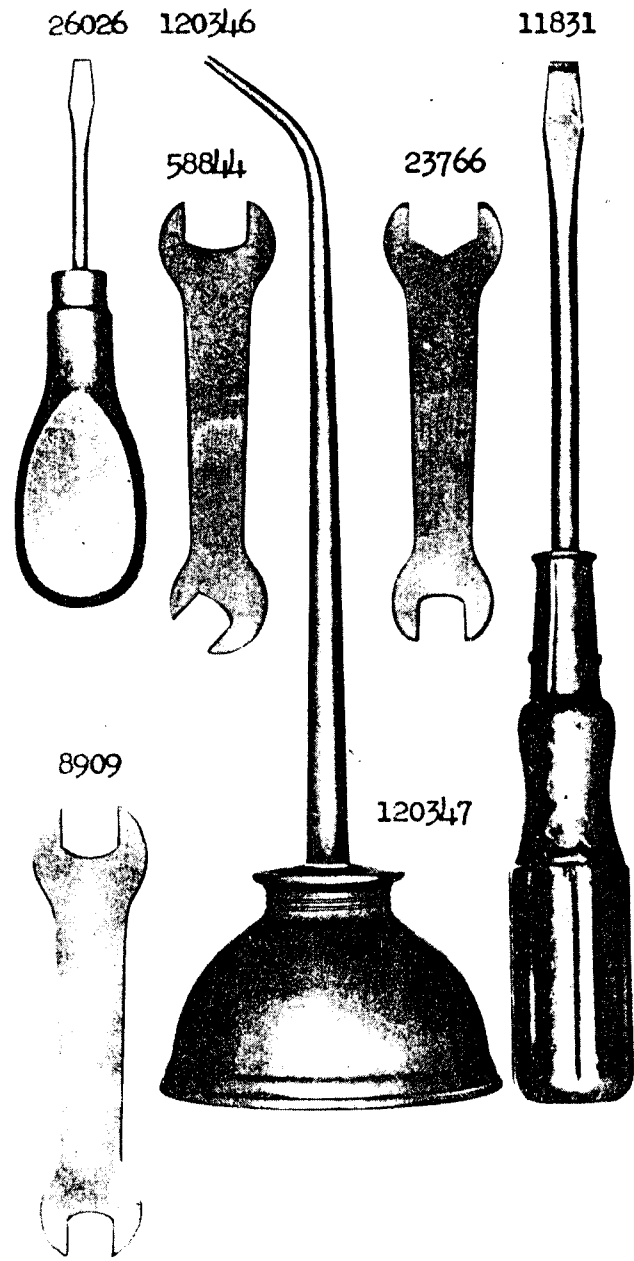


PLATE 22756 - ONE-FOURTH SIZE

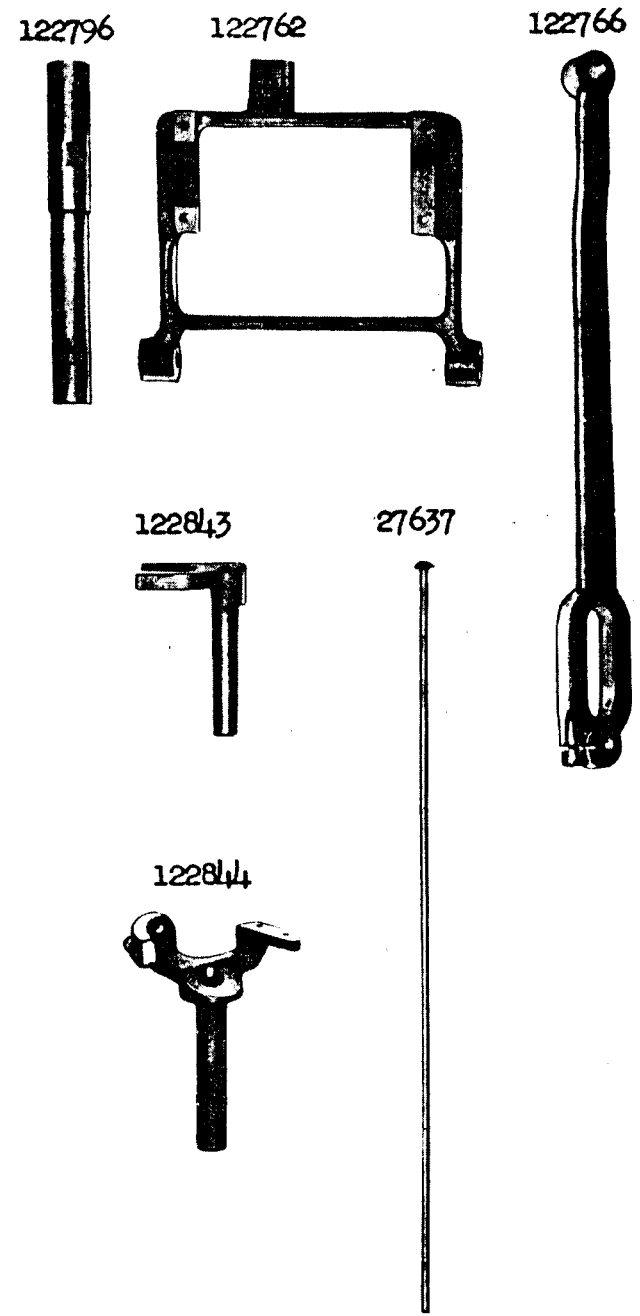


PLATE 22757 - FULL SIZE

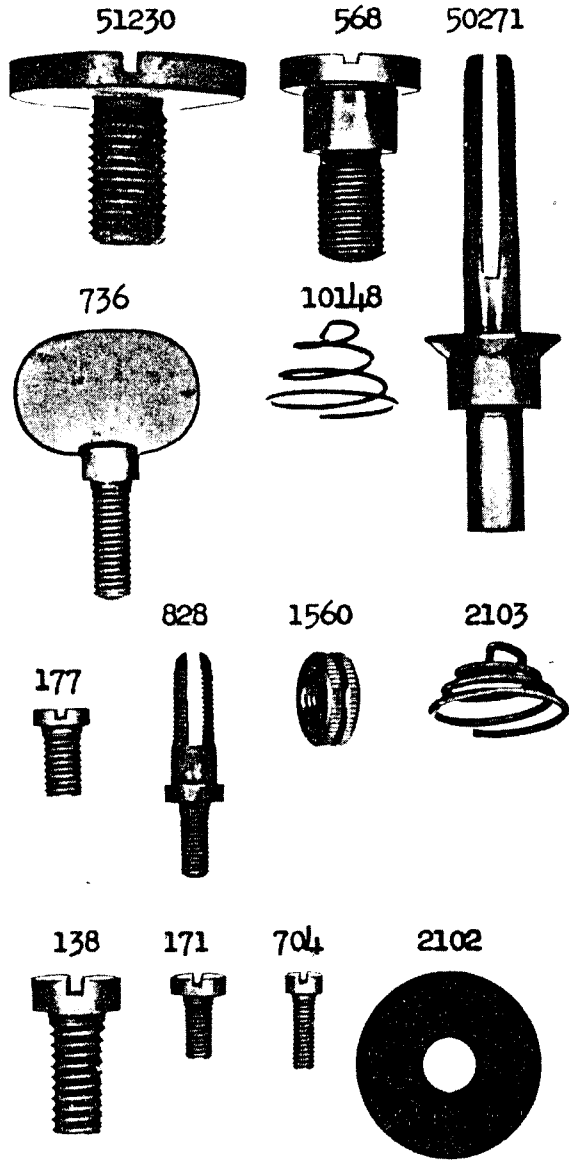


PLATE 22758 - ONE-FIFTH SIZE

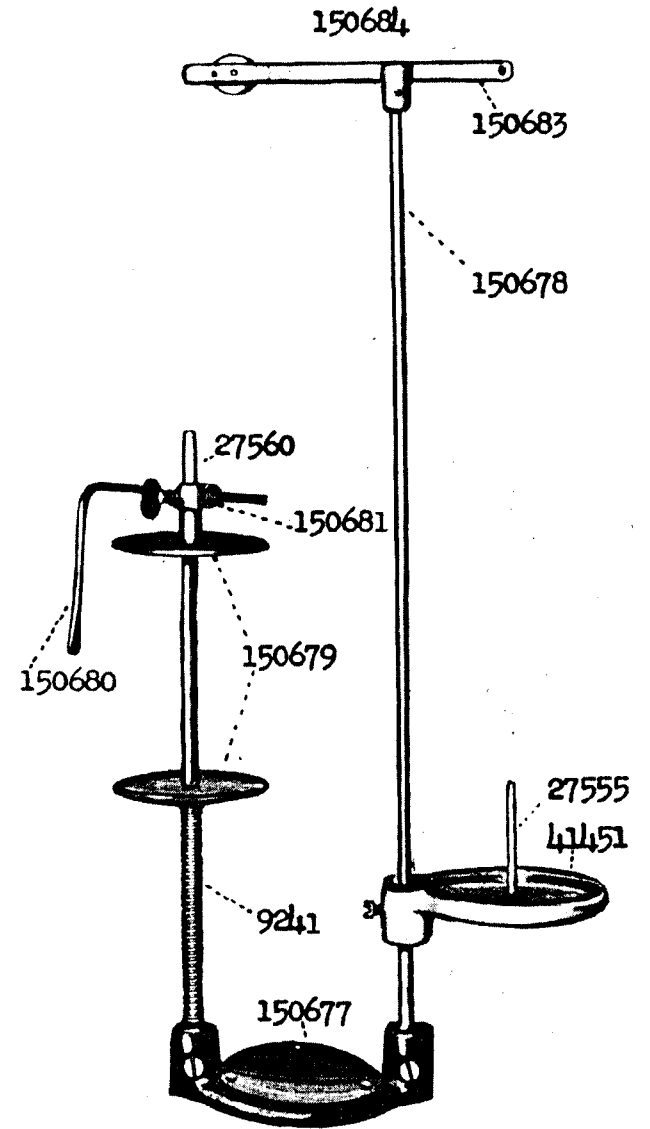


PLATE 22759 - ONE-SIXTH SIZE

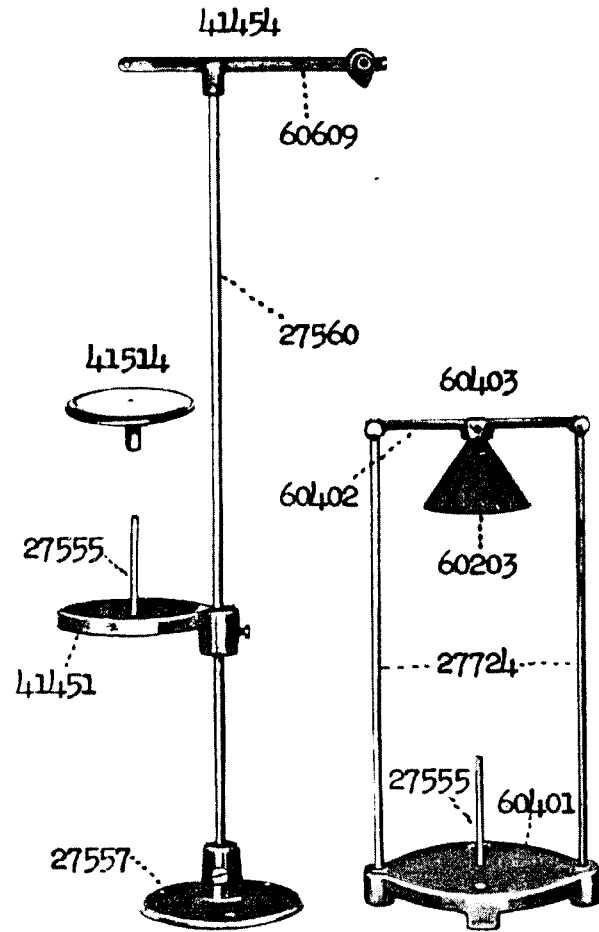


PLATE 22760 - ONE-EIGHTH SIZE

